



@server

xSeries 330

User's Reference



xSeries 330



User's Reference

Note

Before using this information and the product it supports, be sure to read the general information in "Appendix A. Product warranties and notices," on page 133.

First Edition (October 2000)

© **Copyright International Business Machines Corporation 2000. All rights reserved.**

US Government Users Restricted Rights - Use, duplication or disclosure restricted by GSA ADP Schedule Contract with IBM Corp.

Contents

Safety v

Chapter 1. Introducing the xSeries 330 ... 1

Features and specifications	2
Notices used in this book	3
What your xSeries 330 offers	4
Reliability, availability, and serviceability features	5
Server controls and indicators	6
Front view	6
Rear view	7
Turning on the server	8
Turning off the server	9
Stand-by mode	9

Chapter 2. Arranging your workspace ... 11

Comfort	11
Glare and lighting	11
Air circulation	12
Electrical outlets and cable lengths	12

Chapter 3. Configuring your server 13

Using the Configuration/Setup Utility program	14
Starting the Configuration/Setup Utility program	14
Choices available from the Configuration/Setup main menu	15
Using passwords	19
Power-on password	19
Administrator password	20
Using the SCSISelect utility program	21
Starting the SCSISelect utility program	21
Choices available from the SCSISelect menu	21
Using the PXE boot agent utility program	22
Starting the PXE boot agent utility program	22
Choices available from the PXE boot agent utility	23

Chapter 4. Using the ServerGuide CDs .. 25

Features at a glance	26
Setup and configuration overview	27
System Partition	28
Typical NOS installation	28
Setting up or updating multiple servers	29
Installing your NOS without ServerGuide	29
Additional programs included with ServerGuide	29
Error symptoms	30

Chapter 5. Installing Options 31

Major components of the xSeries 330 server	31
System board	32
System board options connectors	32
System board LEDs	34
Before you begin	35
System reliability considerations	35
Working inside a server with power on	35
Handling static sensitive devices	36
Safety information	37
Removing the cover	43
Working with adapters	44
Adapter considerations	45

Installing an adapter	45
Hard disk drives	48
Preinstallation steps	48
Installing or replacing a hard disk drive	49
Memory	50
Installing memory modules	50
Microprocessor	52
Installing the microprocessor	53
Fan assembly replacement	56
Installing the cover	57
I/O connector locations and ports	58
Input/Output ports	58
Serial port	59
Universal Serial Bus ports	60
Console ports	61
C2T device breakout cable	62
Ethernet ports	64
Advanced System Management ports	68
Working with cables	69
Cabling the RS-485 ports	69
Connecting the ASM bus	70
Connecting the servers with a C2T chain	71
Testing the C2T chain	73
Cable management	73

Chapter 6. Solving Problems 75

Diagnostic tools overview	75
POST	77
POST beep code descriptions	78
POST beep codes	80
POST error messages	82
Event/error logs	90
Small computer system interface messages	90
Diagnostic programs and error messages	91
Text messages	92
Starting the diagnostic programs	93
Viewing the test log	94
Diagnostic error message tables	95
Recovering BIOS	103
Identifying problems using status LEDs	105
Light Path Diagnostics	105
Light Path Diagnostics panel	106
Light Path Diagnostics table	107
Troubleshooting charts	109
Troubleshooting an Ethernet controller	115
Network connection problems	115
Ethernet controller troubleshooting chart	116
Ethernet controller messages	117
Novell NetWare or IntraNetWare server ODI driver teaming messages	117
NDIS 4.0 (Windows NT) driver messages	119
Replacing the battery	122
Getting help, service, and information	124
Service support	125
Before you call for service	126
Getting customer support and service	126
Using the World Wide Web	126
Using electronic support services	127
Getting information by fax	127
Getting help online	127
Getting help by telephone	128
Getting help around the world	129

Purchasing additional services	130	Processing date data	143
Enhanced PC support line.....	130	Trademarks	143
900-number operating system and hardware support line	130	Important notes	144
Network and server support line.....	130	Electronic emission notices	144
Ordering support line services.....	131	Federal Communications Commission (FCC) Statement.....	144
Warranty and repair services	131	Industry Canada Class A emission compliance statement	145
Ordering publications	132	Australia and New Zealand Class A statement... ..	145
Appendix A. Product warranties and notices	133	United Kingdom telecommunications safety requirement.....	145
Warranty Statements.....	133	European Union EMC Directive conformance statement	145
IBM Statement of Limited Warranty for United States, Puerto Rico, and Canada (Part 1 - General Terms)	133	Taiwan electrical emission statement	146
IBM Statement of Warranty Worldwide except Canada, Puerto Rico, Turkey, United States (Part 1 - General Terms)	136	Japanese Voluntary Control Council for Interference (VCCI) statement	146
Part 2 - Worldwide Country-Unique Terms.....	138	Power cords	146
Notices	142	Index	149
Edition Notice.....	142		

Safety

Before installing this product, read the Safety Information book.

مج، يجب قراءة دات السلامة

Antes de instalar este produto, leia o Manual de Informações sobre Segurança.

安装本产品前请先阅读《安全信息》手册。

Prije instalacije ovog proizvoda pročitajte priručnik sa sigurnosnim uputama.

Před instalací tohoto produktu si přečtete příručku bezpečnostních instrukcí.

Læs hæftet med sikkerhedsforskrifter, før du installerer dette produkt.

Lue Safety Information -kirjanen, ennen kuin asennat tämän tuotteen.

Avant de procéder à l'installation de ce produit, lisez le manuel Safety Information.

Vor Beginn der Installation die Broschüre mit Sicherheitshinweisen lesen.

Πριν εγκαταστήσετε αυτό το προϊόν, διαβάστε το εγχειρίδιο Safety Information.

לפני שתתקינו מוצר זה, קראו את הוראות הבטיחות.

Przed zainstalowaniem tego produktu należy przeczytać broszurę Informacje Dotyczące Bezpieczeństwa.

Prima di installare questo prodotto, leggere l'opuscolo contenente le informazioni sulla sicurezza.

本製品を導入する前に、安全情報資料を御読みてください。

이 제품을 설치하기 전에, 안전 정보 책자를 읽어보십시오.

Пред да го инсталирате овој производ прочитајте ја книгата со безбедносни информации.

Lees voordat u dit product installeert eerst het boekje met veiligheidsvoorschriften.

Les heftet om sikkerhetsinformasjon (Safety Information) før du installerer dette produktet.

Antes de instalar este produto, leia o folheto Informações sobre Segurança.

Перед установкой продукта прочтите брошюру по технике безопасности (Safety Information).

Pred inštaláciou tohto produktu si pre ítajte Informa nú brožúrku o bezpe nosti.

Preden namestite ta izdelek, preberite knjižico Varnostne informacije.

Antes de instalar este producto, lea la Información de Seguridad.

Läs säkerhetsinformationen innan du installerar den här produkten.

在安裝本產品之前，也請先閱讀「安全性資訊」小冊子。

Installálás el tt olvassa el a Biztonsági el írások kézikönyvét !

Statement 1



DANGER

Electrical current from power, telephone, and communication cables is hazardous. To avoid a shock hazard:

- **Do not connect or disconnect any cables or perform installation, maintenance, or reconfiguration of this product during an electrical storm.**
- **Connect all power cords to a properly wired and grounded electrical outlet.**
- **Connect to properly wired outlets any equipment that will be attached to this product.**
- **When possible, use one hand only to connect or disconnect signal cables.**
- **Never turn on any equipment when there is evidence of fire, water, or structural damage.**
- **Disconnect the attached power cords, telecommunications systems, networks, and modems before you open the device covers, unless instructed otherwise in the installation and configuration procedures.**
- **Connect and disconnect cables as described in the following table when installing, moving, or opening covers on this product or attached devices.**

To connect:

1. Turn everything OFF.
2. First, attach all cables to devices.
3. Attach signal cables to connectors.
4. Attach power cords to outlet.
5. Turn device ON.

To disconnect:

1. Turn everything OFF.
2. First, remove power cords from outlet.
3. Remove signal cables from connectors.
4. Remove all cables from devices.

Statement 2

CAUTION:



When replacing the lithium battery, use only IBM Part Number 33F8354 or an equivalent type battery recommended by the manufacturer. If your system has a module containing a lithium battery, replace it only with the same module type made by the same manufacturer. The battery contains lithium and can explode if not properly used, handled, or disposed of.

Do not:

- Throw or immerse into water.
- Heat to more than 100 C (212 F)
- Repair or disassemble

Dispose of the battery as required by local ordinances or regulations.

Statement 3



CAUTION:

When laser products (such as CD-ROMs, DVD drives, fiber optic devices, or transmitters) are installed, note the following:

- Do not remove the covers. Removing the covers of the laser product could result in exposure to hazardous laser radiation. There are no serviceable parts inside the device.
- Use of controls or adjustments or performance of procedures other than those specified herein might result in hazardous radiation exposure.



DANGER

Some laser products contain an embedded Class 3A or Class 3B laser diode. Note the following. Laser radiation when open. Do not stare into the beam, do not view directly with optical instruments, and avoid direct exposure to the beam.



Class 1 Laser Product
Laser Klasse 1
Laser Klass 1
Luokan 1 Laserlaite
Appareil À Laser de Classe 1

Statement 4

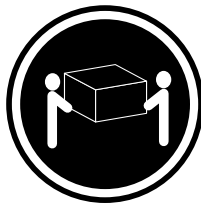

≥18 kg (37 lbs)

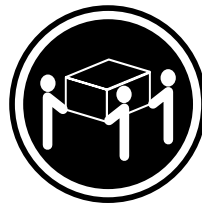

≥32 kg (70.5 lbs)

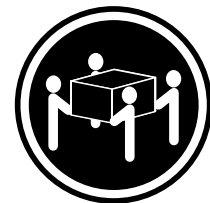

≥55 kg (121.2 lbs)

CAUTION:

Use safe practices when lifting.

Statement 5

CAUTION:



The power control button on the device and the power switch on the power supply do not turn off the electrical current supplied to the device. The device also might have more than one power cord. To remove all electrical current from the device, ensure that all power cords are disconnected from the power source.



Statement 8



CAUTION:

Never remove the cover on a power supply or any part that has the following label attached.



Hazardous voltage, current, and energy levels are present inside any component that has this label attached. There are no serviceable parts inside these components. If you suspect a problem with one of these parts, contact a service technician.

Chapter 1. Introducing the xSeries 330

Your IBM® eServer xSeries 330 server is a one U-high¹ rack model server for high-volume network transaction processing. This high-performance, symmetric multiprocessing (SMP) server is ideally suited for networking environments that require superior microprocessor performance, efficient memory management, flexibility, and reliable data storage.

Your xSeries 330 server comes with a three-year limited warranty and IBM Start Up Support. If you have access to the World Wide Web, you can obtain up-to-date information about your xSeries 330 model and other IBM server products at the following World Wide Web address: <http://www.ibm.com/eserver/xseries>

For service, assistance, or additional information on IBM Server Start Up Support and the World Wide Web, see “Getting help, service, and information” on page 124.

Your server serial number and model number are located on the ID label located on the right edge of the bezel on the server as shown in the illustration below. You will need these numbers when you register your server with IBM.

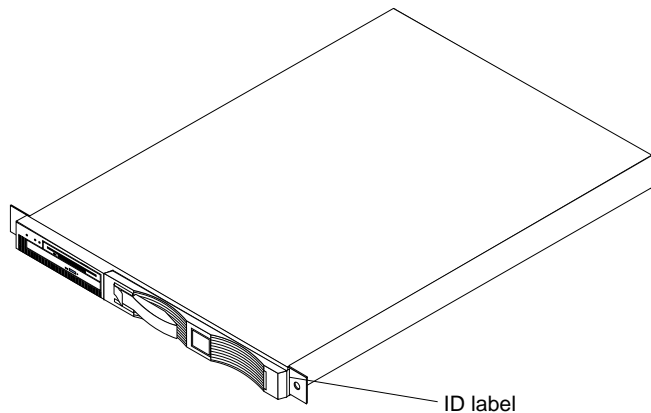

1. Racks are marked in vertical increments of 1.75 inches each. Each increment is referred to as a unit, or a "U". A one-U-high device is 1.75 inches tall.

Features and specifications

The following table provides a summary of the features and specifications for your xSeries 330 server.

<p>Microprocessor:</p> <ul style="list-style-type: none"> • Intel® Pentium® III microprocessor with MMX™ technology and SIMD extensions • 256 KB Level-2 cache • Supports up to two microprocessors <p>Memory:</p> <ul style="list-style-type: none"> • Standard: 256 MB • Maximum: 4 GB • Type: 133 MHz, ECC, SDRAM, Registered DIMMs • Slots: 4 dual inline <p>Drives standard:</p> <ul style="list-style-type: none"> • Diskette: 1.44 MB • CD-ROM: 24X IDE <p>Expansion bays:</p> <ul style="list-style-type: none"> • Two 3.5-inch slim high bays for LVD SCSI hard disk drives <p>PCI expansion slots:</p> <ul style="list-style-type: none"> • Two 33 MHz/64-bit <p>Power supply:</p> <p>One 200 watt (115-230 Vac)</p> <p>Video:</p> <ul style="list-style-type: none"> • S3 video controller (integrated on system board) • Compatible with SVGA • 8 MB SDRAM video memory 	<p>Size</p> <ul style="list-style-type: none"> • Height 43.69 mm (1.72") • Depth: 653.29 mm (25.72") • Width: 439.93 mm (17.32") • Weight: approximately 12.7 kg (28lb) when fully configured <p>Integrated functions:</p> <ul style="list-style-type: none"> • Advanced System Management processor • One Ultra160 SCSI controller • Two 10BASE-T/100BASE-TX Intel Ethernet controllers • Two Universal Serial Bus (USB) ports • Two RS-485 Advanced System Management processor ports (one In, one Out) • One serial port • Two console ports (one In, one Out) <p>Acoustical noise emissions:</p> <ul style="list-style-type: none"> • Sound power, idling: 6.1 bel maximum • Sound power, operating: 6.2 bel maximum 	<p>Environment:</p> <ul style="list-style-type: none"> • Air temperature: <ul style="list-style-type: none"> – Server on: 10° to 35° C (50.0° to 95.0° F). Altitude: 0 to 914 m (2998.7 ft.) – Server on: 10° to 32° C (50.0° to 89.6° F). Altitude: 914 m (2998.7 ft.) to 2133 m (6998.0 ft.) – Server off: 10° to 43° C (50.0° to 109.4° F). Maximum altitude: 2133 m (6998.0 ft.) • Humidity: <ul style="list-style-type: none"> – Server on: 8% to 80% – Server off: 8% to 80% <p>Heat output:</p> <p>Approximate heat output in British Thermal Units (BTU) per hour</p> <ul style="list-style-type: none"> • Minimum configuration: 273 BTU (80 watts) • Maximum configuration: 751 BTU (220 watts) <p>Electrical input:</p> <ul style="list-style-type: none"> • Sine-wave input (50-60 Hz) required • Input voltage low range: <ul style="list-style-type: none"> – Minimum: 100 V ac – Maximum: 127 V ac • Input voltage high range: <ul style="list-style-type: none"> – Minimum: 200 V ac – Maximum: 240 V ac • Input kilovolt-amperes (kVA) approximately: <ul style="list-style-type: none"> – Minimum: 0.08 kVA – Maximum: 0.22 kVA
--	--	--

Table 1. Features and Specifications

Notices used in this book

This information product contains notices that relate to a specific topic. The Caution and Danger notices also appear in the multilingual safety information provided with your product. Each safety notice is numbered for easy reference to the corresponding notices in the safety information on the *IBM xSeries Documentation CD*.

The following is a list of the notices and their definitions as used in this book:

- **Notes:** These notices provide important tips, guidance, or advice.
- **Important:** These notices provide information or advice that might help you avoid inconvenient or problem situations.
- **Attention:** These notices indicate possible damage to programs, devices, or data. An attention notice is placed just before the instruction or situation in which damage could occur.
- **Caution:** These notices indicate situations that can be potentially hazardous to you. A caution notice is placed just before the description of potentially hazardous procedure step or situation.
- **Danger:** These notices indicate situations that can be potentially lethal or extremely hazardous to you. A danger notice is placed just before the description of potentially lethal or extremely hazardous procedure step or situation.

What your xSeries 330 offers

The unique design of your server takes advantage of advancements in symmetric multiprocessing (SMP), data storage, and memory management. Your server combines:

- **Impressive performance using an innovative approach to SMP**

Your server supports up to two Pentium III microprocessors. Your server comes with one microprocessor installed; you can install an additional microprocessor to enhance performance and provide SMP capability.

- **Large system memory**

The memory bus in your server supports up to 4 gigabytes (GB) of system memory. The memory controller provides error correcting code (ECC) support for up to four industry standard PC133, 3.3 V, 168-pin, 8-byte, registered, synchronous-dynamic-random access memory (SDRAM) dual inline memory modules (DIMMs).

- **System-management capabilities**

Your server comes with a Advanced System Management Processor on the system board. This processor, in conjunction with the systems-management software that is provided with your server, enables you to manage the functions of the server locally and remotely. The Advanced System Management Processor also provides system monitoring, event recording, and dial-out alert capability.

Note: The Advanced System Management Processor is sometimes referred to as the service processor.

Refer to the documentation provided with your systems-management software for more information.

- **Integrated network environment support**

Your server comes with two Ethernet controllers on the system board. Each Ethernet controller has an interface for connecting to 10-Mbps or 100-Mbps networks. The server automatically selects between 10BASE-T and 100BASE-TX. Each controller provides full-duplex (FDX) capability, which allows simultaneous transmission and reception of data on the Ethernet local area network (LAN).

- **IBM ServerGuide CDs**

The ServerGuide CDs that are included with your server provide programs to help you set up your server and install the network operating system (NOS). The ServerGuide program detects the hardware options that are installed, and provides the correct configuration programs and device drivers. In addition, the ServerGuide CDs include a variety of application programs for your server.

For more information about the ServerGuide CDs, see the documentation provided with your ServerGuide software.

Reliability, availability, and serviceability features

Three of the most important features in server design are reliability, availability, and serviceability (RAS). These factors help to ensure the integrity of the data stored on your server; that your server is available when you want to use it; and that should a failure occur, you can easily diagnose and repair the failure with minimal inconvenience.

The following is an abbreviated list of the RAS features that your server supports.

- Menu-driven setup, system configuration, RAID configuration, and diagnostic programs
- Power-on self-test (POST)
- Integrated Advanced System Management Processor
- Predictive Failure Alerts (PFA)
- Remote system problem-analysis support
- Power and temperature monitoring
- Hot-swap drive bays
- Error codes and messages
- System error logging
- Upgradable BIOS, diagnostics, and Advanced System Management Processor code
- Automatic restart after a power failure
- Parity checking on the PCI buses
- CRC checking on the SCSI buses
- Error checking and correcting (ECC) memory
- Redundant Ethernet capabilities
- Light Path Diagnostics on the system board
- Vital Product Data (VPD) on system board, and SCSI backplane
- Customer support center 24 hours per day 7 days a week²

²Service availability will vary by country. Response time will vary depending on the number and nature of incoming calls.

Server controls and indicators

This section identifies the controls and indicators on the front and the back of your server.

Front view

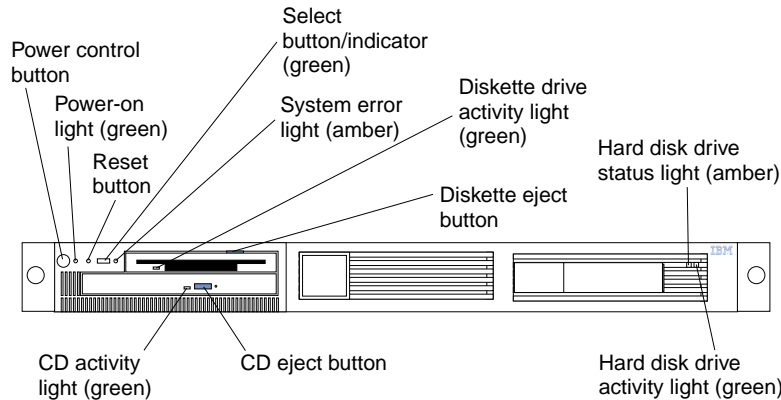

Power-control button: Press this button to manually turn the server on or off.

Power-on light: This green LED lights and stays on when you turn on your server and blinks when the server is in stand-by mode.

Reset button: Press this button to reset the server and run the power-on self-test (POST). You might need to use a pen or the end of a straightened paper clip to press the button.

Select button/indicator: Press this button to select the server in the C2T chain. The green LED on this button lights when the monitor, keyboard, and mouse are logically connected to this server.

System-error light: This amber LED lights when a system error occurs. An LED on the Light Path Diagnostic panel on the system board will also be on to further isolate the error.

Diskette drive activity light: When this LED is on, it indicates that the diskette drive is in use.

Diskette-eject button: Push this button to release a diskette from the drive.

Hard disk drive status light: Each of the hot-swap drives has a hard disk drive status light. When this amber LED is on continuously, the drive has failed. This status light is active only with a ServeRAID adapter installed in the server.

Hard disk drive activity light: Each of the hot-swap drives has a Hard Disk Activity light. When this green LED is flashing, the controller is accessing the drive.

CD eject button: Push this button to release a CD from the drive.

CD drive activity light: When this light is on, it indicates that the CD-ROM drive is in use.

Rear view

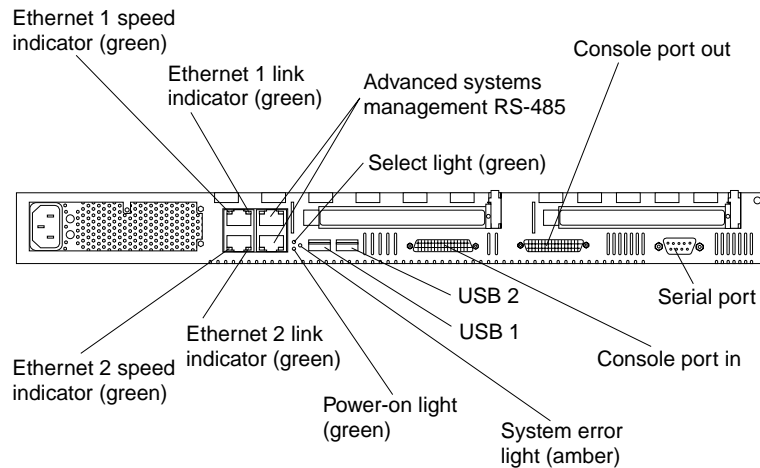

Ethernet 1 speed indicator: This green LED lights when the speed of the Ethernet LAN that is connected to Ethernet port 1 is 100 Mbps.

Ethernet 1 link indicator: This green LED lights when there is an active link connection on the 10BASE-T or 100BASE-TX interface for Ethernet port 1.

Advanced system management: The RS-485 ports are used for creating a system management bus between several servers.

Select light: This green LED lights when the monitor, keyboard, and mouse are logically connected to this server. This light duplicates the Select button LED on the front of the server.

Console port out: This port is used to connect the server to a keyboard, monitor, and pointing device. It is also used to connect multiple servers together to share a single keyboard, monitor, and pointing device.

Serial port: Signal cables for modems or other serial devices connect here to the 9-pin serial port connector.

Console port in: This port is used to connect multiple servers together to share a single keyboard, monitor, and pointing device.

USB 2: Universal Serial Bus 2

USB 1: Universal Serial Bus 1

System-error light: This amber LED lights when a system error occurs. An LED on the Light Path Diagnostic panel on the system board will also be on to further isolate the error. This light duplicates the system error light on the front of the server.

Power-on light: This green LED lights and stays on when you turn on your server and will blink when the server is in standby mode. This light duplicates the power on light on the front of the server.

Ethernet 2 link indicator: This green LED lights when there is an active link connection on the 10BASE-T or 100BASE-TX interface for Ethernet port 2.

Ethernet 2 speed indicator: This green LED lights when the speed of the Ethernet LAN connected to Ethernet port 2 is 100 Mbps.

Turning on the server

Turning on the server refers to the act of plugging the power cord of your server into the power source and starting the operating system.

Complete the following steps to turn on the server:

1. Plug the power cord of your server into the power source.

Note: Plugging the power cord into a power source may cause the server to start automatically. This is an acceptable action.

2. Wait 30 seconds then press the power control button on the front of the server.

Statement 5



CAUTION:

The power control button on the device and the power switch on the power supply do not turn off the electrical current supplied to the device. The device also might have more than one power cord. To remove all electrical current from the device, ensure that all power cords are disconnected from the power source.

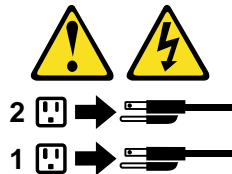

Turning off the server

Turning off the server refers to the act of disconnecting the server from the power source.

Complete the following steps to turn off the server:

1. Refer to your operating system documentation for the proper procedure to shut down the operating system.

Note: Each operating system is different. Some will allow an immediate shut down, while others require an orderly shut-down procedure.

2. Press the power control button on the front of the server. This will put the server in stand-by mode.

3. Disconnect the server from the power source.

Note: After you turn off the server, wait at least 5 seconds before you turn on the server again.

Stand-by mode

Stand-by puts the server in a wait state. When in a wait state, the server is not running the operating system, and all core logic is shut down except for the service processor.

Complete the following steps to put the server into the stand-by mode:

1. Refer to your operating system documentation for the proper procedure to shut-down the operating system.

Note: Each operating system is different. Read all the documentation about shutting down the operating system before continuing.

2. Press the power control button on the front of the server.

Chapter 2. Arranging your workspace

To get the most from your server, arrange both the equipment you use and your work area to suit your needs and the kind of work you do. Your comfort is of foremost importance, but light sources, air circulation, and the location of electrical outlets also can affect the way you arrange your workspace.

Comfort

Although no single working position is ideal for everyone, here are a few guidelines to help you find a position that suits you best.

Sitting in the same position for a long time can cause fatigue. A good chair can make a big difference. The backrest and seat should adjust independently and provide good support. The seat should have a curved front to relieve pressure on the thighs. Adjust the seat so that your thighs are parallel to the floor and your feet are either flat on the floor or on a footrest.

When using the keyboard, keep your forearms parallel to the floor and your wrists in a neutral, comfortable position. Try to keep a light touch on the keyboard and your hands and fingers relaxed. You can change the angle of the keyboard for maximum comfort by adjusting the position of the keyboard feet.

Adjust the monitor so the top of the screen is at, or slightly below, eye level. Place the monitor at a comfortable viewing distance, usually 51 to 61 cm (20 to 24 in.), and position it so you can view it without having to twist your body. Also position other equipment you use regularly, such as the telephone or a mouse, within easy reach.

Glare and lighting

Position the monitor to minimize glare and reflections from overhead lights, windows, and other light sources. Even reflected light from shiny surfaces can cause annoying reflections on your monitor screen. Place the monitor at right angles to windows and other light sources, when possible. Reduce overhead lighting, if necessary, by turning off lights or using lower wattage bulbs. If you install the monitor near a window, use curtains or blinds to block the sunlight. You might have to adjust the Brightness and Contrast controls on the monitor as the room lighting changes throughout the day.

Where it is impossible to avoid reflections or to adjust the lighting, an antiglare filter placed over the screen might be helpful. However, these filters might affect the clarity of the image on the screen; try them only after you have tried all other methods of reducing glare.

Dust buildup compounds problems that are associated with glare. Remember to clean your monitor screen periodically using a soft cloth that is moistened with a nonabrasive liquid glass cleaner.

Air circulation

Your server and monitor produce heat. Your server has one or more fans that pull in fresh air and force out hot air. The monitor lets hot air escape through vents. Blocking the air vents can cause overheating, which might result in a malfunction or damage. Place the server and monitor so that nothing blocks the air vents; usually, 15 cm (6 inches) of air space is sufficient. Also, make sure that the vented air is not blowing on someone else.

Electrical outlets and cable lengths

The location of electrical outlets and the length of power cords and cables that connect to the monitor, printer, and other devices might determine the final placement of your server.

When arranging your workspace:

- Avoid the use of extension cords. When possible, plug the server power cords directly into electrical outlets.
- Keep power cords and cables neatly routed away from walkways and other areas where they might get kicked accidentally.

For more information about power cords, refer to the power cord information in this on-line publication.

Chapter 3. Configuring your server

The following configuration programs are provided with your server:

- **Configuration/Setup Utility**

The Configuration/Setup Utility program is part of the *basic input/output system (BIOS)* code that comes with your server. You can use this program to configure serial port assignments, change interrupt request (IRQ) settings, change the drive startup sequence, set the date and time, and set passwords.

- **SCSISelect Utility**

With the built-in SCSISelect Utility program, you can configure the devices that are attached to the integrated SCSI controller. Use this program to change default values, resolve configuration conflicts, and perform a low-level format on a SCSI hard disk drive.

- **PXE Boot Agent Utility**

The Preboot eXecution Environment (PXE) Boot Agent Utility program is part of the *basic input/output system (BIOS)* code that comes with your server. You can use this program to change network boot protocols and boot order, to select OS wake up support, and to set menu wait times.

- **ServerGuide CDs**

The ServerGuide CDs include software setup and installation tools specifically designed for IBM servers. You can use these CDs during the initial installation of your server to configure the server hardware and simplify your network operating system installation. The ServerGuide CDs also contain a collection of application programs, which you can install after your server is up and running. See “Chapter 4. Using the ServerGuide CDs,” on page 25 for more detailed information.

- **ServeRAID programs**

If you have a ServeRAID adapter installed in your server, you must use the ServeRAID configuration program to define and configure your disk-array subsystem before you install your operating system.

Using the Configuration/Setup Utility program

This section provides the instructions needed to start the Configuration/Setup Utility program and descriptions of the menu choices available.

Starting the Configuration/Setup Utility program

To start the Configuration/Setup Utility program:

1. Turn on the server and watch the monitor screen.
2. When the message Press F1 for Configuration/Setup appears, press F1.
Note: If you have set both levels of passwords (user and administrator), you must enter the administrator password to access the full Configuration/Setup menu.
3. Follow the instructions that appear on the screen.

Choices available from the Configuration/Setup main menu

From the Configuration/Setup Utility main menu, you can select settings that you want to change. The Configuration/Setup Utility main menu is similar to the following:

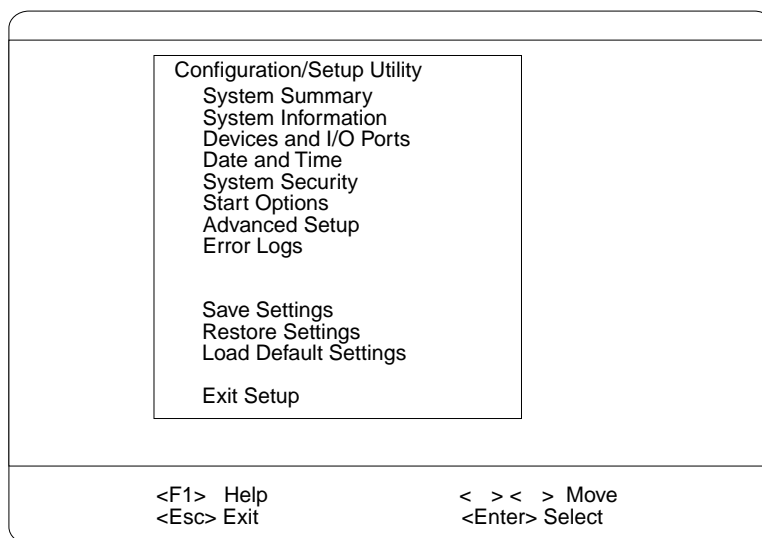

Notes:

1. You can press F1 to display Help information for a selected menu item.
2. The choices on some menus might differ slightly, depending on the BIOS version in your server.

Descriptions of the choices available from the main menu are as follows:

- **System Summary**

Select this choice to display configuration information. This includes the type and speed of the microprocessors and the amount of memory installed.

Changes that you make to configuration settings appear on this summary screen. You cannot edit the fields.

This choice appears on both the full and limited Configuration/Setup Utility menus.

- **System Information**

Select this choice to display information about your server. Changes that you make on other menus might appear on this summary screen. You cannot edit any fields. The System Information choice appears only on the full Configuration/Setup Utility main menu.

- **Product Data**

Select this choice to view system information, such as the machine type and model, the server serial number, and the revision level or issue date of the BIOS stored in the flash electronically erasable programmable ROM (EEPROM).

- **System Card Data**

Select this choice to view vital product data (VPD) for some server components.

- **Devices and I/O Ports**

Select this choice to view or change the assignments for devices and input/output ports. This choice appears only on the full Configuration/Setup Utility main menu.

This choice also allows you to enable or disable the integrated SCSI, and Ethernet controllers.

- The default setting is Enable for all the controllers. If you select Disable, the system will not configure the disabled device and the operating system will not see the device. (This is equivalent to unplugging the device.)
- If the on-board SCSI controller is disabled and no other storage-device controller is installed, operating system startup cannot occur.

Select **System Service Processor Settings** to view the interrupt-request setting (IRQ) used by the Advanced System Management Processor (system service processor). You can then use the arrow keys to select a new IRQ setting for the Advanced System Management Processor from the list of available choices.

- **Date and Time**

Select this choice to set the system date and time and to change the system time sent to the Advanced System Management Processor (service processor) when the server is started. This choice appears only on the full Configuration/Setup Utility main menu.

The system time is in a 24-hour format: hour:minute:second.

You can set a time delta to be added or subtracted from the system time that is sent to the service processor (Advanced System Management Processor) each time the server is started. Use the number keys to enter the hours and minutes and + or – to add or subtract from the system time. If you want the system clock time to be the same as the Advanced System Management Processor clock time, leave the value set at its default of 0.

- **System Security**

Select this choice to set passwords or a system owner's name. This choice appears only on the full Configuration/Setup Utility main menu.

You can implement two levels of password protection:

- **Power-on Password**

Select this choice to set or change a power-on password. See “Using passwords” on page 19 for more information.

- **Administrator Password**

Select this choice to set or change an administrator password.

Attention: If an administrator password is set and then forgotten, it cannot be overridden or removed. You must replace the system board.

The administrator password provides access to all choices on the Configuration/Setup Utility main menu. You can set, change, or delete both the administrator and power-on passwords, and allow a power-on password to be changed by the user.

See “Using passwords” on page 19 for more information.

- **Start Options**

Select this choice to view or change the start options. This choice appears only on the full Configuration/Setup Utility main menu. Start options take effect when you start your server.

You can select keyboard operating characteristics, such as the keyboard speed. You also can specify whether the keyboard number lock starts on or off. You also can enable the server to run without a diskette drive, monitor, or keyboard.

Note: To determine if you should configure your server to operate without a keyboard see the table on page 71.

The server uses a startup sequence to determine the device from which the operating system loads. For example, you can define a startup sequence that checks for a startable diskette in the diskette drive, then checks the hard disk drive in bay 1, and then checks a network adapter.

If the **Boot Fail Count** choice is enabled, you must restart the system three times to restore the system BIOS default settings. If this choice is disabled, the system BIOS defaults can only be restored from the Configuration/Setup Utility main menu.

You can enable a virus-detection test that checks for changes in the master boot record at startup.

- **Advanced Setup**

Select this choice to change values for advanced hardware features, such as cache control and PCI configuration. This choice appears only on the full Configuration/Setup Utility main menu.

A warning message appears above the choices on this menu to alert you that the system might malfunction if these options are configured incorrectly. Follow the instructions on the screen carefully.

- **Processor Serial Number Access**

Select this choice to identify if the microprocessor serial number in the microprocessor is readable.

- **System Partition Visibility**

Select this choice to identify if the System Partition is visible. To make the System Partition visible, set this value to **Visible**. To make the System Partition invisible, set this value to **Hidden**.

- **Core Chipset Control**

Select this choice to modify settings that control features of the core chip set on the system board.

Attention: Do not make changes here unless directed to do so by an IBM authorized service representative.

- **Cache Control**

Select this choice to enable or disable the microprocessor cache. In addition, you can set the microprocessor cache mode to write-back (WB) or write-through (WT). Selecting write-back mode will provide the maximum system performance.

- **PCI Slot/Device Information**

Select this choice to view and identify system resources used by PCI devices. PCI devices automatically communicate with the server configuration information. This usually results in automatic configuration of a PCI device.

Attention: You must use the menu selections to save custom settings for the PCI Slot/Device Information choice. The save, restore and load default settings choices on the main menu of the Configuration/Setup Utility do not save the PCI Slot/Device Information settings.

PCI Device Control allows you to enable or disable the PCI slots from this menu.

- The default setting is Enable for all the PCI slots. If you select Disable, the system will not configure the disabled device and the operating system will not see the device. (This is equivalent to unplugging the device.)

- **Memory Settings**

Select this choice to manually disable or enable a bank of memory.

If a memory error is detected during POST or memory configuration, the server can automatically disable the failing memory bank and continue operating with reduced memory capacity. If this occurs, you must manually enable the memory bank after the problem is corrected. Select **Memory Settings** from the Advanced Setup menu, use the arrow keys to highlight the bank that you want to enable; then, use the arrow keys to select **Enable**.

- **Error Logs**

Select this choice to view or clear error logs.

- Select **POST Error Log** to view the three most recent error codes and messages that the system generated during POST.

Select **Clear error logs** from the POST Error Log menu to clear the error log.

- Select **System Event/Error Log** to view the system event/error log. The system event/error log contains all the system error and warning messages that the system has generated. You can use the arrow keys to move between pages in the system event/error log.

Select **Clear error logs** from the System Event/Error Log menu to clear the error or event log.

- **Save Settings**

Select this choice to save your customized settings.

- **Restore Settings**

Select this choice to delete your changes and restore the previous settings.

- **Load Default Settings**

Select this choice to cancel your changes and restore the factory settings.

- **Exit Setup**

If you have made any changes, the program will prompt you to save the changes or exit without saving the changes.

Using passwords

The **System Security** choice appears only on the full Configuration/Setup Utility menu. After you select this choice, you can implement two levels of password protection: power-on password and administrator password.

Power-on password

After you set a power-on password, you can enable the unattended-start mode. This locks the keyboard and mouse, but allows the system to start the operating system. The keyboard and mouse remain locked until you enter the correct password.

You can use any combination of up to seven characters (A-Z, a-z, 0-9, and blanks) for your power-on password. Keep a record of your password in a secure place. If you forget the power-on password, you can regain access to the server through one of the following methods:

- If an administrator password is set, enter the administrator password at the power-on prompt. Start the Configuration/Setup Utility program and change the power-on password.
- Change the position of the password override jumper as described in “Setting the password override switch”.
- Remove the battery and then install the battery.

Setting the password override switch: The following illustration shows the location of the password override switch, switch 8 of switch block 1, on the system board.

Note: The illustrations in this document might differ slightly from your hardware.

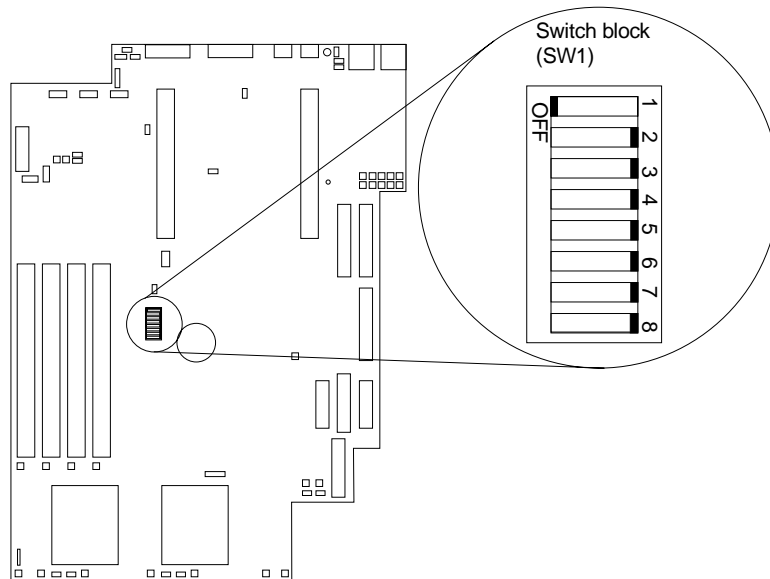

To set the password override switch:

1. Review the information in “Safety information” on page 37.
2. Turn off the server and peripheral devices and disconnect all external cables and power cords; then, remove the cover. See “Removing the cover” on page 43.
3. Toggle switch 8 on switch block 1 on the system board. This clears the power-on password for one boot cycle.

Note: This means that you can now start or power-up the server one time without having to use the power-on password. But if you do not use the Configuration/Setup Utility program to change or delete the password, the next time you start the server the original power-on password will be reinstated.

4. Connect the server to a power source, keyboard, monitor, and mouse.
5. Power-up the server.

Note: You can now start the Configuration/Setup Utility program and either delete the old or set a new power-on password.

Administrator password

Select this choice to set an administrator password. The administrator password provides access to all choices on the Configuration/Setup Utility main menu. You can set, change, or delete both the administrator and power-on passwords, and allow a power-on password to be changed by the user.

Attention: If an administrator password is set and then forgotten, it cannot be overridden or removed. You must replace the system board.

The following table provides a summary of the password features.

Type of password	Results
Power-on password	<ul style="list-style-type: none"> • Enter the password to complete the system startup. • All choices are available on the Configuration/Setup Utility main menu.
Administrator password	<ul style="list-style-type: none"> • No password is required to start the system. • Enter the password to access the Configuration/Setup Utility program. • All choices are available on the Configuration/Setup Utility main menu.
Administrator <i>and</i> power-on password	<ul style="list-style-type: none"> • You can enter either password to complete the system startup. • The administrator password provides access to all choices on the Configuration/Setup Utility main menu. You can set, change, or delete both the administrator and power-on passwords, and allow a power-on password to be changed by the user. • The power-on password provides access to a limited set of choices on the Configuration/Setup Utility main menu. This limited access might include changing or deleting the power-on password.

Table 2. Power-on and administrator password features

Using the SCSISelect utility program

SCSISelect is a built-in, menu-driven configuration utility program that you can use to:

- View the default SCSI IDs
- Locate and correct configuration conflicts
- Perform a low-level format on a SCSI hard disk

The following sections provide the instructions needed to start the SCSISelect Utility and descriptions of the menu choices available.

Note: If your server has a RAID adapter installed, use the configuration method supplied with the RAID adapter to view or change SCSI settings for attached devices.

Starting the SCSISelect utility program

To start the SCSISelect utility program:

1. Turn on the server.
2. When the <<< Press <CTRL><A> for SCSISelect™ Utility! >>> prompt appears, press Ctrl+A.

Note: If an administrator password has been set, a prompt appears asking you to enter the password to start the SCSISelect Utility program.

3. Use the arrow keys to select a choice from the menu.
 - Press Esc to return to the previous menu.
 - Press the F5 key to switch between color and monochrome modes (if your monitor permits).
4. Follow the instructions on the screen to change the settings of the selected items; then, press Enter.

Choices available from the SCSISelect menu

The following choices appear on the SCSISelect Utility menu:

- **Configure/View Host Adapter Settings**

Select this choice to view or change the SCSI controller settings. To reset the SCSI controller to its default values, press F6; then, follow the instructions that appear on the screen.

You can view or change the following controller settings:

 - **Host Adapter SCSI ID**

Select this choice to view the SCSI controller ID, normally 7.
 - **SCSI Parity Checking**

Select this choice to view the assigned value of *Enabled*.
 - **Host Adapter SCSI Termination**

Select this choice to view the assigned value of *Enabled*.
 - **Boot Device Options**

Select this choice to configure startable device parameters. Before you can make updates, you must know the ID of the device whose parameters you want to configure.

- **SCSI Device Configuration**
Select this choice to configure SCSI device parameters. Before you can make updates, you must know the ID of the device whose parameters you want to configure.
Note: The Maximum Sync Transfer Rate represents the transfer rate for Ultra SCSI devices.
 - The transfer rate for Ultra3 SCSI LVD devices is 160.0
 - The transfer rate for Ultra2 SCSI LVD devices is 80.0
 - The transfer rate for Fast SCSI devices is 20.0
- **Advanced Configuration Options**
Select this choice to view or change the settings for advanced configuration options.
- **SCSI Disk Utilities**
Select this choice to view the SCSI IDs that are assigned to each device or to format a SCSI device.
To use the utility program, select a drive from the list. Read the screens carefully before making a selection.
Note: If you press Ctrl+A before the selected drives are ready, an Unexpected SCSI Command Failure screen might appear. Restart the server and watch the SCSISelect messages as each drive spins up. After the drive that you want to view or format spins up, press Ctrl+A.

Using the PXE boot agent utility program

The PXE boot agent is a built-in, menu-driven configuration utility program that you can use to:

- Change network startup (boot) protocols
- Change startup (boot) order
- Select whether or not to display setup prompt
- Set menu wait time
- Select OS wake up support

Starting the PXE boot agent utility program

The following sections provide the instructions needed to start the PXE Boot Agent Utility and descriptions of the menu choices available.

To start the PXE Boot Agent Utility program:

1. Turn on the server.
2. When the Initializing Intel (R) Boot Agent Version X.X.XX PXE 2.0 Build XXX (WfM 2.0) prompt appears, press Ctrl+S.
Note: By default you will have two seconds after the prompt appears on the screen to press Ctrl+S.
3. Use the arrow keys or press Enter to select a choice from the menu.
 - Press Esc to return to the previous menu.
 - Press the F4 key to exit.
4. Follow the instructions on the screen to change the settings of the selected items; then, press Enter.

Choices available from the PXE boot agent utility

The following choices appear on the PXE boot agent utility menu:

- **Network Boot Protocol**

PXE is the default value for this menu item.

Note: Do not change this value. There are no other network boot protocols supported.
- **Boot Order**

Select this choice to change the order in which boot devices are queried.

 - Try local drives first, then network (Default)
 - Try network only
 - Try local drives only
 - Try network first, then local drives
- **Show setup prompt**

Select this choice to either display the PXE setup prompt or disable it. Disable is the default setting.

When this choice is enabled, **Press Ctrl+S to enter the setup menu** will appear on the screen under the initializing prompt.
- **Setup time wait menu**

Select this choice to set the amount of time (in seconds) that the system will pause during initialization for a Ctrl+S input.

 - 2 seconds (Default)
 - 3 seconds
 - 5 seconds
 - 8 seconds
- **Legacy OS wake up support**

Select this choice to allow/disallow a non-Windows operating system to use the adapter remote wake up capability.

 - Disabled (Default)
 - Enabled

Chapter 4. Using the ServerGuide CDs

The ServerGuide CDs include easy-to-use software setup and installation tools that are specifically designed for your IBM server. The ServerGuide Setup and Installation program detects the server model and hardware options that are installed and uses that information during setup to configure the hardware. The ServerGuide tools simplify NOS installations by providing updated device drivers, and in some cases, installing them automatically.

If a newer version of the ServerGuide software is available, you can purchase an update package. For details, see the ServerGuide Updates form that comes with your server library, or go to the ServerGuide fulfillment Web site at <http://www.ibm.com/pc/coupon>

The ServerGuide software has these features to make setup easier:

- An easy-to-use interface with online help
- Diskette-free setup, and configuration programs that are based on detected hardware
- *Performance Optimizer* program, which easily tunes your server for your environment
- A system BIOS update program, which updates the BIOS directly from the CD
- Device drivers that are provided for your server model and detected hardware
- NOS partition size and file-system type that are selectable during setup
- Powerful application programs and administration tools

Features at a glance

The following is a summary of ServerGuide features.

Note: Exact features and functions can vary with different versions of the ServerGuide software. To learn more about the version that you have, start the *Setup and Installation* CD and view the online Overview.

Setup and Installation CD	Setup and Installation CD (continued)	System Updates and Applications CD (continued)
<p>Note: The ServerGuide program requires a supported IBM server with an <i>enabled</i> startable (bootable) CD-ROM drive. Not all features are supported on all models.</p> <ul style="list-style-type: none"> • Sets system date and time. • Detects the ServeRAID adapter or controller and runs the ServeRAID configuration program. • Updates the licensed internal code (firmware) level without creating diskettes. • Checks the system BIOS level to determine whether a later level is available from the CD. You can update BIOS without creating diskettes. • Updates firmware for Advanced System Management adapters and controllers. • Provides the Performance Optimizer program to easily tune your server for your environment. • Creates a System Partition on the default drive. You can run server-specific utility programs after setup. • Detects installed hardware options and provides updated device drivers for most adapters and devices. 	<ul style="list-style-type: none"> • Creates a <i>Setup Replication Diskette</i> for replicating setup selections for other servers of the same model. • Provides diskette-free installation for Windows 2000, Windows NT, and NetWare operating systems. • Provides a replicated installation path for multiple Windows 2000, Windows NT Server 4.0, and Windows Enterprise Edition, and Red Hat Linux. • Includes an online README file with links to tips for your hard-ware and NOS installation. <p>Note: Installation requires your NOS CD.</p> <p>System Updates and Applications CD</p> <ul style="list-style-type: none"> • Creates diagnostic, RAID, device driver, and other support diskettes from the CD; or with an Internet connection, you can check for an update from a dedicated IBM file transfer protocol (FTP) server. • Installs some updates without requiring diskettes. Where applicable, you can run executable files directly from the CD or unzip files to any drive on your server or another server on your network. 	<ul style="list-style-type: none"> • Includes a vast library of fully tested device drivers for your server. • Includes a search function to help you locate updates by title or keywords. • Installs powerful applications directly from the CD. See the CD label for a current list of applications.

Setup and configuration overview

When you use the *Setup and Installation* CD, you do not need setup diskettes. You can use the CD to configure any supported IBM server model. The setup program checks your system BIOS, service processors, and other system hardware to determine if system updates are available. The setup program provides a list of tasks that are required to set up your server model. On RAID servers, you can run the ServeRAID Manager program to create logical drives.

Note: Exact features and functions can vary with different versions of the ServerGuide software.

When you start the *Setup and Installation* CD, the following happens:

- You are prompted for your language, country, and keyboard layout. (This information is stored and later passed on to the NOS installation program.)
- ServerGuide displays choices for running the configuration programs. For example:
 - The Express Configuration method runs the required programs for your server, based on the hardware that is detected.
 - The Custom Configuration method displays all programs that are available for your server, and you decide which programs to run.
 - The Replicated Configuration method provides the option of duplicating your setup selections to other servers that are the same model.
- If you select the Custom Configuration method, the following programs are optional. If you select the Express Configuration method, some or all of these programs are run, depending on the hardware that is detected.
 - The Set Date and Time feature is provided so that you do not have to use the Configuration/Setup Utility program to access these settings.
 - ServerGuide checks the server BIOS and microcode (firmware) levels for supported options and then checks the CD for a newer level. CD content can be newer than the hardware. ServerGuide can perform a flash update of the BIOS.
 - The ServeRAID configuration program starts, leading you through the entire configuration process.
 - The Performance Optimizer program easily tunes your server for your environment.
 - ServerGuide creates a System Partition on the default drive.
- ServerGuide displays a confirmation summary, so that you will know when you have completed all the required tasks. Then, you are ready to install your NOS.

Notes:

1. Plug and Play adapters are configured automatically. Non-Plug and Play adapters or non-IBM adapters might require switch settings, additional device drivers, and installation after the NOS is installed. See the documentation that comes with the adapter.
2. Diagnostics for your server come in BIOS or on a separate diagnostic CD.

System Partition

ServerGuide creates a 50 MB System Partition on the default drive. The System Partition contains server-specific utility programs such as service processor disk operating system (DOS) utilities, system diagnostics, flash BIOS updates, and other programs.

Note: Programs in the System Partition vary by server model, and not all server models run utility programs from the System Partition. To determine which ones do, start the *Setup and Installation* CD and view the online Overview.

After setup is complete, you can access programs in the System Partition by restarting the server and pressing Alt+F1 when the prompt is displayed. The System Partition menu displays the programs that are available on your server model.

Typical NOS installation

You can use ServerGuide to shorten your installation time. ServerGuide provides the necessary device drivers, based on the hardware that you have and the NOS that you are installing. The following is a brief explanation of a typical ServerGuide NOS installation.

Note: Exact features and functions can vary with different versions of the ServerGuide software

- After you have completed the setup process, the operating system installation program starts. (You will need your copy of the NOS CD to complete the installation.)
- ServerGuide stores information about the server model, service processor, hard disk controllers, and network adapters. It then checks the CD for newer device drivers. This information is stored and then passed to the NOS installation program.
- With some NOS installations, you can create a *NOS Replication Diskette* for setting up additional servers. The diskette will contain the Internet protocol (IP) address, server name, and other selections.
- ServerGuide presents NOS partition options that are based on your NOS selection and the installed hard disk drives.
- If you are installing the NOS from diskette, ServerGuide displays the required diskettes that you must create, and the optional diskettes that you might want to create. The diskettes that you can create are the device driver diskettes for the installed adapters or controllers.

ServerGuide prompts you to insert your NOS CD and restart the server. At this point, the installation program for the NOS (for example, Microsoft Windows 2000) takes control to complete the installation.

Setting up or updating multiple servers

You can use ServerGuide to create diskettes that help you set up or update multiple servers. You can modify information on the diskettes as you use them to set up or update other servers.

Note: Availability and function can vary by server model and by the hardware that is installed.

You can create a *Setup Replication Diskette*, which contains your hardware configuration selections. Use this diskette to replicate selections to other servers that are of the same model.

You can create a *NOS Replication Diskette*, which contains your server name, domain name, and other information that you need to complete multiple installations. This feature supports systems running Windows 2000, Windows NT Server 4.0, and Red Hat Linux.

Installing your NOS without ServerGuide

If you have already configured the server hardware and you decide not to use ServerGuide to install your NOS, download the latest NOS installation instructions:

1. Go to <http://www.ibm.com/pc/support>
2. Click **Servers**.
3. From the **Family** field, select your server model.
4. Click **OS installation**. The available installation instructions are listed.

Additional programs included with ServerGuide

As a convenience, ServerGuide comes with additional software to assist you with the server installation.

A variety of powerful applications are included with ServerGuide. Offerings can vary with the different versions of the ServerGuide software. Check the application CD labels for a list of applications, or start the *Setup and Installation* CD and view the online Overview.

Error symptoms

This section provides ServerGuide error symptoms and probable solutions.

Setup and Installation CD	Action
Setup and Installation CD will not start.	<ul style="list-style-type: none">• Ensure that the system is a supported server model with a startable (bootable) CD-ROM drive.• If the startup (boot) sequence settings have been altered, be sure that the CD-ROM is first in the startup sequence.• If more than one CD-ROM drive is installed, be sure that only one drive is set as the primary drive. Start the CD from the primary drive.
ServeRAID program cannot view all installed drives or cannot install NOS.	<ul style="list-style-type: none">• Ensure that there are no duplicate SCSI IDs or IRQ assignments.• Ensure that the hard disk drive is connected properly.
The operating system installation program continuously loops.	Free up more space on the hard disk.
ServerGuide will not start your NOS CD.	Ensure that the NOS CD is supported by ServerGuide. See the <i>Setup and Installation CD</i> label for a list of supported NOS versions.
Cannot install NOS.	Ensure that the NOS is supported on your server. If the NOS is supported, either there is no logical drive defined (ServeRAID systems) or the ServerGuide System Partition is not present. Run the ServerGuide setup and configuration program and ensure that the setup is complete.

System Updates and Applications CD	Action
Get "time out" or "Unknown host" errors.	Ensure that you have access to the Internet through FTP directly.

Chapter 5. Installing Options

This chapter provides instructions to help you add options to your server. Some option-removal instructions are provided, in case you need to remove one option to install another. For a list of supported options for your server, see the Server Proven list at: <http://www.ibm.com/pc/compat>.

Major components of the xSeries 330 server

The following illustration shows the locations of major components in your server.

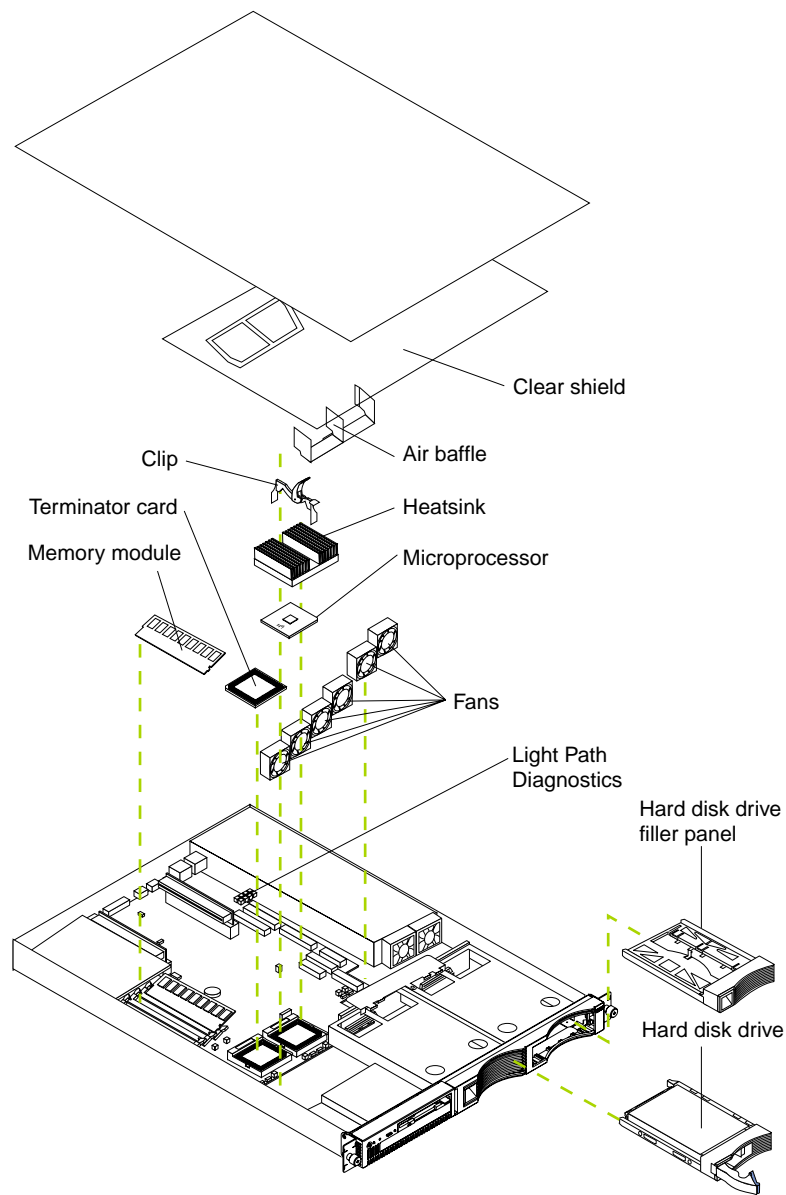

System board

The illustrations in the following sections show the components on the system board.

System board options connectors

The following illustration identifies the connectors on the system board.

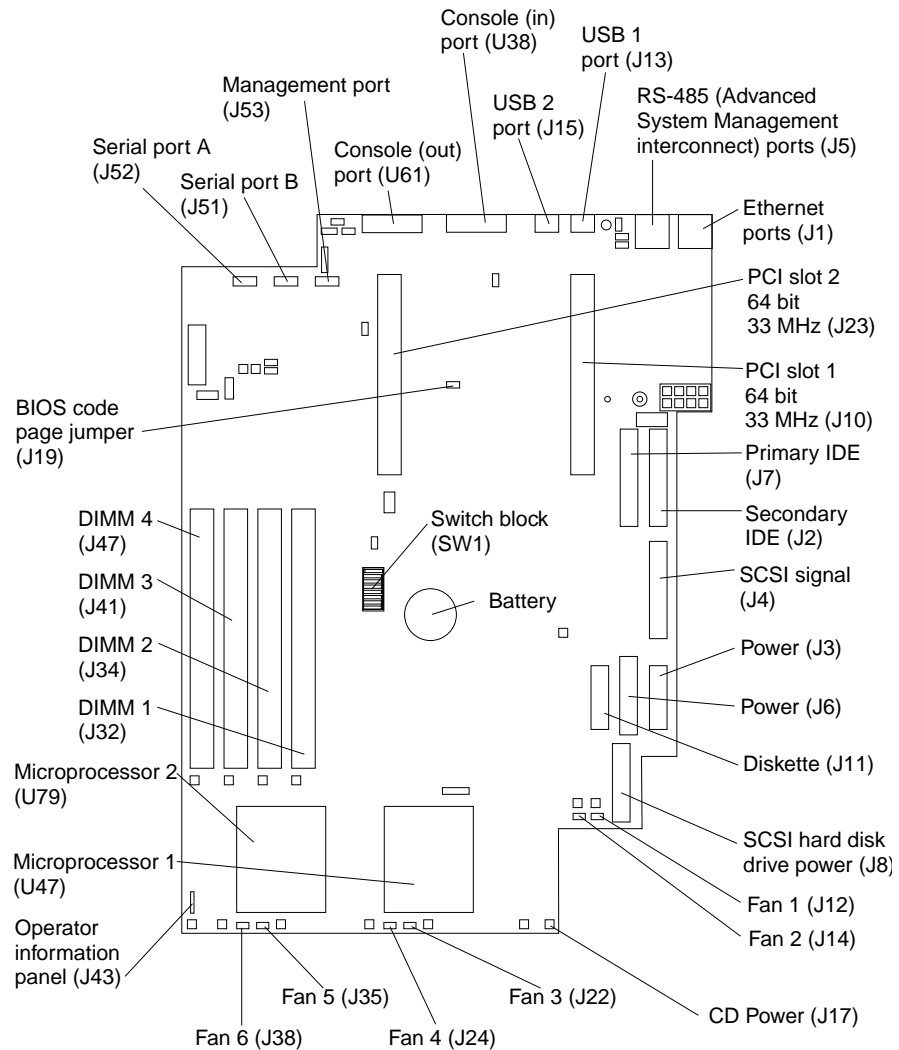

System board jumper blocks

Any jumper blocks on the system board that are not shown in the illustration are reserved. For normal operation of the system, no jumpers should be installed on any of the jumper blocks. See "Recovering BIOS" on page 103 for information about the Flash ROM page-swap jumper.

System board switch block

The switch block contains microswitches 1-8. As pictured in this illustration, switch 1 is at the top of the switch block and switch 8 is at the bottom. For a more information about this switch block see “Setting the password override switch” on page 19.

The following table describes the function for each switch.

Switch number	Switch description
1	Reserved.
2	Reserved.
3	Reserved.
4	Reserved.
5	Reserved. The default setting is Off (disabled).
6	Reserved. The default setting is Off.
7	Reserved. The default setting is Off.
8	Bypass power-on password. When toggled to the opposite position, bypasses the power-on password, if one is set. Refer to “Setting the password override switch” on page 19.

Table 3. Switches 1-8

System board LEDs

The following illustration identifies the LEDs on the system board.

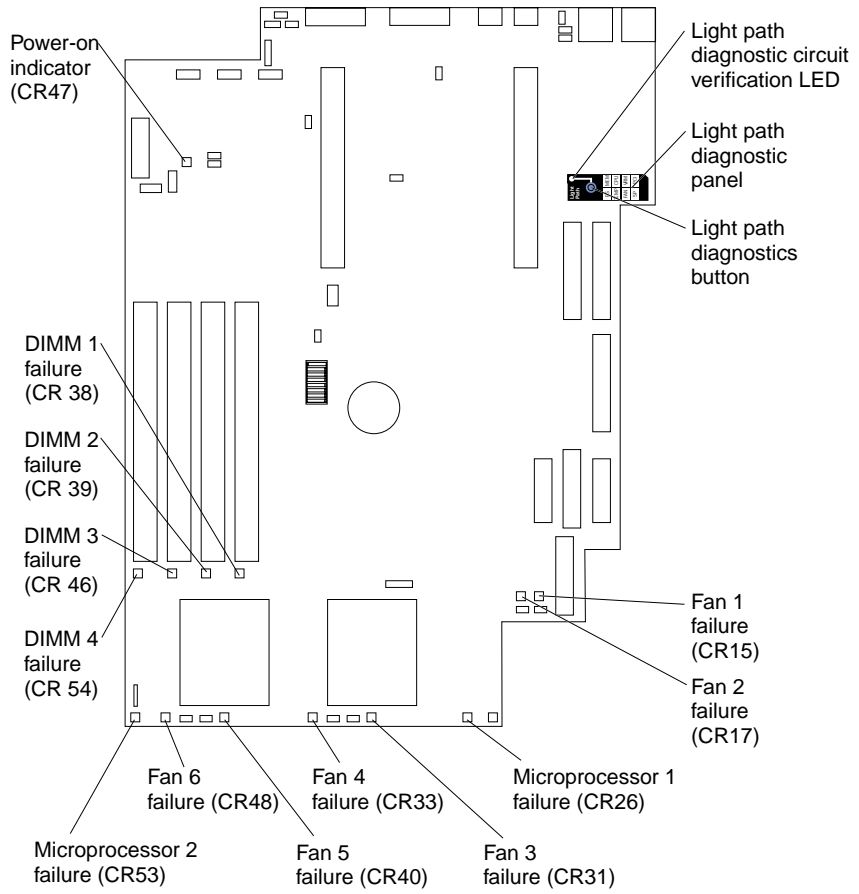

Before you begin

Before you begin to install options in your server, read the following information:

- Become familiar with the safety and handling guidelines specified under “Handling static sensitive devices” on page 36, and read the safety statements in “Safety information,” beginning on page 37. These guidelines will help you work safely while working with your server or options.
- Make sure that you have an adequate number of properly grounded electrical outlets for your server, monitor, and any other options that you intend to install.
- Back up all important data before you make changes to disk drives.
- Have a small, flat-blade screwdriver available.
- For a list of supported options for your server, refer to <http://www.ibm.com/pc/us/compat> on the World Wide Web.
- For your convenience during setup and service you might want to have a separate location where you can temporarily connect the server to a power source (using a separate power cord), keyboard, monitor, and mouse (using a separate C2T device breakout cable). Additional C2T cables are available in the cable option kit.

System reliability considerations

To help ensure proper cooling and system reliability, make sure:

- Each of the drive bays has either a drive or a filler panel installed.
- The cover is in place during normal operations, or is removed for no longer than 30 minutes while the server is operating.
- There is space around the server to allow the server cooling system to work properly. Leave about 127 mm (5 in.) of space around the front and rear of the server.
- Cables for optional adapters are routed according to the instructions provided with the adapters.
- A failed fan is replaced within 48 hours.

Working inside a server with power on

Your server is designed to operate safely while turned on with the cover removed. Follow these guidelines when you work inside a server that is turned on:

- Avoid loose-fitting clothing on your forearms. Button long-sleeved shirts before working inside the server; do not wear cuff links while you are working inside the server.
- Do not allow your necktie or scarf to hang inside the server.
- Remove jewelry, such as bracelets, rings, necklaces, and loose-fitting wrist watches.
- Remove items from your shirt pocket (such as pens or pencils) that could fall into the server as you lean over it.
- Take care to avoid dropping any metallic objects, such as paper clips, hair pins, or screws, into the server.

Handling static sensitive devices

Attention: Static electricity can damage electronic devices and your system. To avoid damage, keep static sensitive devices in their static protective bag until you are ready to install them.

To reduce the possibility of electrostatic discharge, observe the following precautions:

- Limit your movement. Movement can cause static electricity to build up around you.
- Handle the device carefully, holding it by its edges or its frame.
- Do not touch solder joints, pins, or exposed printed circuitry.
- Do not leave the device where others can handle and possibly damage the device.
- While the device is still in its anti-static package, touch it to an unpainted metal part of the system unit for at least two seconds. (This drains static electricity from the package and from your body).
- Remove the device from its package and install it directly into your system unit without setting it down. If it is necessary to set the device down, place it on its static-protective package. (If your device is an adapter, place it component side up). Do not place the device on your system unit cover or on a metal table.
- Take additional care when handling devices during cold weather as heating reduces indoor humidity and increases static electricity.

Safety information

Before installing this product, read the Safety Information book.

مج، يجب قراءة دات السلامة

Antes de instalar este produto, leia o Manual de Informações sobre Segurança.

安装本产品前请先阅读《安全信息》手册。

Prije instalacije ovog proizvoda pročitajte priručnik sa sigurnosnim uputama.

Před instalací tohoto produktu si přečtěte příručku bezpečnostních instrukcí.

Læs hæftet med sikkerhedsforskrifter, før du installerer dette produkt.

Lue Safety Information -kirjanen, ennen kuin asennat tämän tuotteen.

Avant de procéder à l'installation de ce produit, lisez le manuel Safety Information.

Vor Beginn der Installation die Broschüre mit Sicherheitshinweisen lesen.

Πριν εγκαταστήσετε αυτό το προϊόν, διαβάστε το εγχειρίδιο Safety Information.

לפני שתתקינו מוצר זה, קראו את הוראות הבטיחות.

Przed zainstalowaniem tego produktu należy przeczytać broszurę Informacje Dotyczące Bezpieczeństwa.

Prima di installare questo prodotto, leggere l'opuscolo contenente le informazioni sulla sicurezza.

本製品を導入する前に、安全情報資料を御読みください。

이 제품을 설치하기 전에, 안전 정보 책자를 읽어보십시오.

Пред да го инсталирате овој производ прочитајте ја книгата со безбедносни информации.

Lees voordat u dit product installeert eerst het boekje met veiligheidsvoorschriften.

Les heftet om sikkerhetsinformasjon (Safety Information) før du installerer dette produktet.

Antes de instalar este produto, leia o folheto Informações sobre Segurança.

Перед установкой продукта прочтите брошюру по технике безопасности (Safety Information).

Pred inštaláciou tohto produktu si pre ítajte Informa nú brožúrku o bezpe nosti.

Preden namestite ta izdelek, preberite knjižico Varnostne informacije.

Antes de instalar este producto, lea la Información de Seguridad.

Läs säkerhetsinformationen innan du installerar den här produkten.

在安裝本產品之前，也請先閱讀「安全性資訊」小冊子。

Installálás el tt olvassa el a Biztonsági el írások kézikönyvét !

Statement 1



DANGER

Electrical current from power, telephone, and communication cables is hazardous. To avoid a shock hazard:

- Do not connect or disconnect any cables or perform installation, maintenance, or reconfiguration of this product during an electrical storm.
- Connect all power cords to a properly wired and grounded electrical outlet.
- Connect to properly wired outlets any equipment that will be attached to this product.
- When possible, use one hand only to connect or disconnect signal cables.
- Never turn on any equipment when there is evidence of fire, water, or structural damage.
- Disconnect the attached power cords, telecommunications systems, networks, and modems before you open the device covers, unless instructed otherwise in the installation and configuration procedures.
- Connect and disconnect cables as described in the following table when installing, moving, or opening covers on this product or attached devices.

To connect:

1. Turn everything OFF.
2. First, attach all cables to devices.
3. Attach signal cables to connectors.
4. Attach power cords to outlet.
5. Turn device ON.

To disconnect:

1. Turn everything OFF.
2. First, remove power cords from outlet.
3. Remove signal cables from connectors.
4. Remove all cables from devices.

Statement 2

CAUTION:



When replacing the lithium battery, use only IBM Part Number 33F8354 or an equivalent type battery recommended by the manufacturer. If your system has a module containing a lithium battery, replace it only with the same module type made by the same manufacturer. The battery contains lithium and can explode if not properly used, handled, or disposed of.

Do not:

- Throw or immerse into water.
- Heat to more than 100 C (212 F)
- Repair or disassemble

Dispose of the battery as required by local ordinances or regulations.

Statement 3



CAUTION:

When laser products (such as CD-ROMs, DVD drives, fiber optic devices, or transmitters) are installed, note the following:

- Do not remove the covers. Removing the covers of the laser product could result in exposure to hazardous laser radiation. There are no serviceable parts inside the device.
- Use of controls or adjustments or performance of procedures other than those specified herein might result in hazardous radiation exposure.



DANGER

Some laser products contain an embedded Class 3A or Class 3B laser diode. Note the following. Laser radiation when open. Do not stare into the beam, do not view directly with optical instruments, and avoid direct exposure to the beam.



Class 1 Laser Product
Laser Klasse 1
Laser Klass 1
Luokan 1 Laserlaite
Appareil À Laser de Classe 1

Statement 4

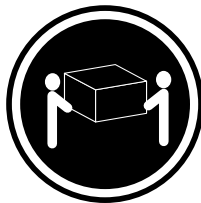

≥18 kg (37 lbs)

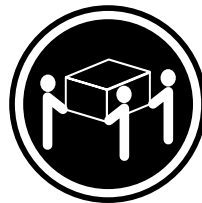

≥32 kg (70.5 lbs)

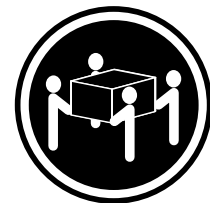

≥55 kg (121.2 lbs)

CAUTION:

Use safe practices when lifting.

Statement 5

CAUTION:



The power control button on the device and the power switch on the power supply do not turn off the electrical current supplied to the device. The device also might have more than one power cord. To remove all electrical current from the device, ensure that all power cords are disconnected from the power source.



Statement 8



CAUTION:

Never remove the cover on a power supply or any part that has the following label attached.

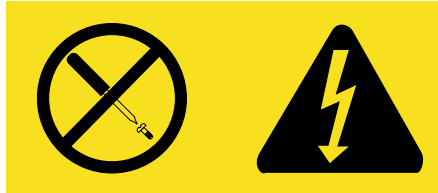

Hazardous voltage, current, and energy levels are present inside any component that has this label attached. There are no serviceable parts inside these components. If you suspect a problem with one of these parts, contact a service technician.

Removing the cover

The following information describes how to remove the cover.

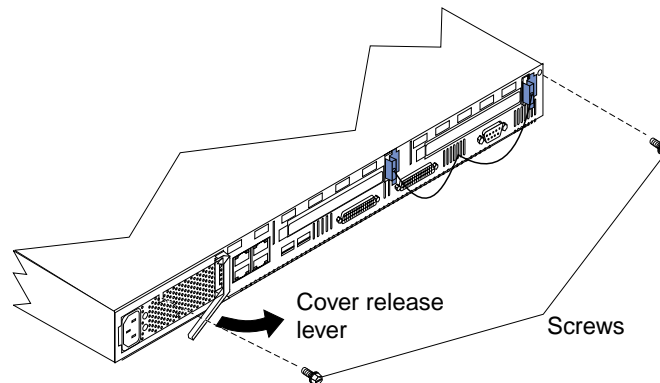

Complete the following steps to remove the server cover:

1. Review the information in “Safety information” on page 37 and “Working inside a server with power on” on page 35.
2. Turn off the server and all attached devices and disconnect all external cables and power cords.
3. Remove the server from the rack.
4. Remove the two screws from the rear of the server.
5. Pull out on the cover release lever at the back of the server, to release the cover.
6. Slide the cover back, then up and off the server.

Attention: For proper cooling and airflow, replace the cover before turning on the server. Operating the server for extended periods of time (over 30 minutes) with the cover removed might damage server components.

7. Remove the clear shield that covers the inside of the server.

Note: It is not necessary to remove the shield when you are installing memory modules or installing an adapter in the PCI slots.

Working with adapters

Your server comes with two peripheral component interconnect (PCI) adapter slots on the system board with riser cards installed in them.

Attention: Your server also comes with an integrated video controller on the system board. When you install a video adapter in a PCI slot, the server BIOS automatically disables the integrated video controller. This allows the video adapter in the PCI slot to control the video functions for your monitor.

The following illustration shows the location of the 33 MHz PCI expansion slots on the system board.

Note: The illustrations in this document might differ slightly from your hardware.

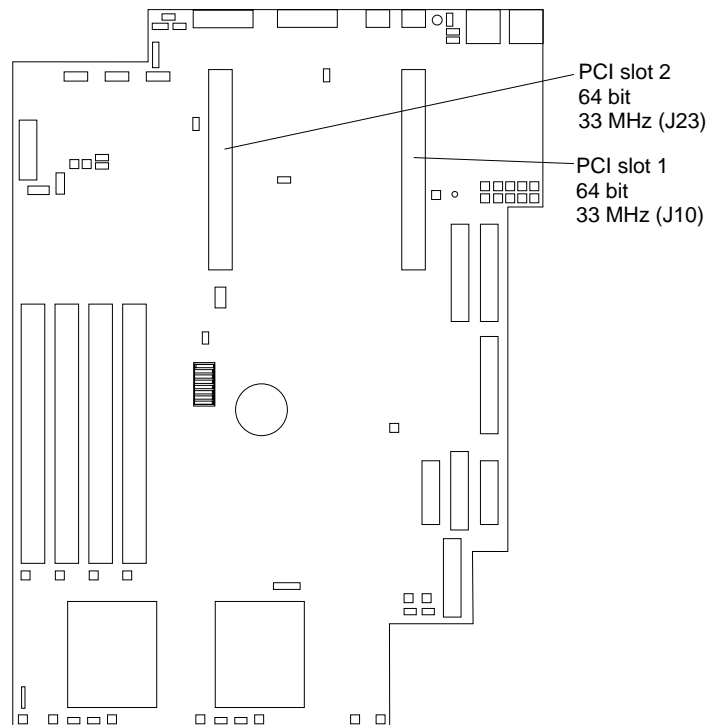

Adapter considerations

Before you install adapters, review the following:

- Locate the documentation that comes with the adapter and follow those instructions in addition to the instructions in this chapter. If you need to change the switch settings or jumper settings on your adapter, follow the instructions that come with the adapter.
- You can install 32-bit or 64-bit full-length or half-length adapters in the expansion slots. Full-length adapters are installed in slot 1; half-length adapters are installed in either slot 1 or 2.
- Your server supports 5.0V and universal PCI adapters; it does not support 3.3V only adapters.
- Your server uses a rotational interrupt technique to configure PCI adapters. Because of this technique, you can install PCI adapters that currently do not support sharing of PCI interrupts.
- PCI slots 1 and 2 and the integrated SCSI controller are on PCI bus B; the system board and all other integrated devices are on PCI bus A.
Note: PCI bus A = bus 0; PCI bus B = bus 1.
- The system scans PCI slots 1 and 2 to assign system resources. By default the system starts (boots) devices in the following order: System SCSI devices, then PCI devices.
Note: To change the boot precedence, start the Configuration/Setup Utility, select **Start Options** from the main menu; then, select the **PCI SCSI adapter boot option**.

Installing an adapter

Complete the following steps to install an adapter:

Attention: When you handle electrostatic discharge (ESD) sensitive devices, take precautions to avoid damage from static electricity. For details on handling these devices, refer to “Handling static sensitive devices” on page 36.

1. Review the information in “Safety information” on page 37.
2. Turn off the server and peripheral devices.
3. Remove all external cables from the server; then, remove the server from the rack and remove the cover as shown. For more information, see “Removing the cover” on page 43 for instructions.

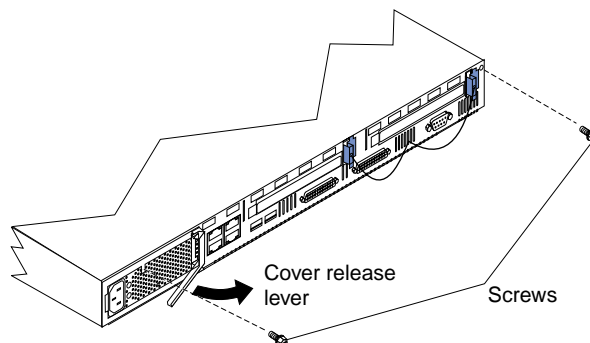

4. Remove the expansion slot clip that holds the expansion slot cover in place by sliding it upward and off the frame of the server.

Note: The illustrations in this document might differ slightly from your hardware.

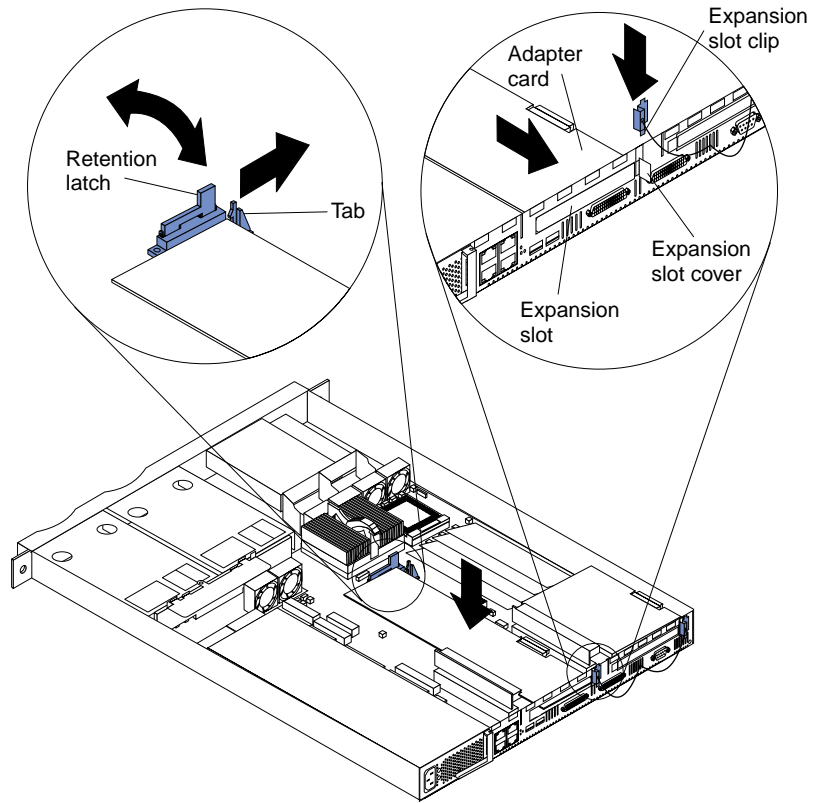

5. Remove the expansion-slot cover.
6. Refer to the documentation that comes with your adapter for any cabling instructions.
Attention: You should route adapter cables before you install the adapter.
7. Set any jumpers or switches as described by the adapter manufacturer.

8. Install the adapter:

Note: When installing an adapter into slot 2, skip steps a and d.

- a. Open the adapter retention latch by pushing the blue tab to release it. Then push the latch up to the full open position.
- b. Carefully grasp the adapter by its top edge or upper corners, and align it with the connector on the PCI riser-card.
- c. Press the adapter *firmly* into the riser-card connector.

Attention: When you install an adapter, be sure the adapter is correctly seated in the riser-card connector before you turn on the server. Improperly seated adapters might cause damage to the system board, the riser-card, or the adapter.

- d. Push down on the blue adapter retention latch until it clicks into place, securing the adapter.
- e. Replace the expansion slot clip by sliding it down until it latches into place and holds the adapter securely.

9. Connect the internal cables to the adapter.

Attention: Route cables so that they do not block the flow of air from the fans.

Note: When installing a ServeRAID adapter remove the cable from the SCSI connector (J4) on the system board and attach it to the ServeRAID adapter.

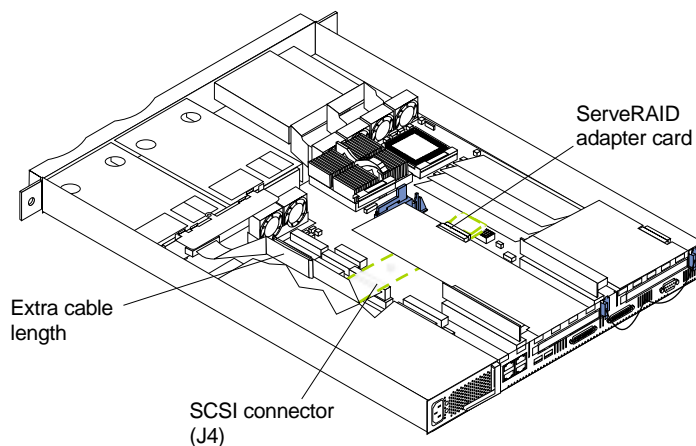

10. Replace the cover on the server; then, reinstall the server in the rack and connect all external cables. For more information see “Installing the cover” on page 57 for instructions.

11. Turn on the server.

Hard disk drives

Your server supports two, 1-inch (26 mm) slim 3.5-inch low voltage differential (LVD) hard disk drives.

Note: You can hot swap a hard disk drive only if a ServeRAID adapter configured as RAID 1 is installed in your system. If you use any other ServeRAID or SCSI configuration, you can not hot swap the hard disk drive.

Each hard disk drive tray has a status and an activity light located on the upper-right corner of tray (see “Major components of the xSeries 330 server” on page 31 for the location of the status and activity indicators). These lights are used to show when there is drive activity or, in some cases, when there is a problem with your hard disk drive.

- The drive must be a low voltage differential drive (LVD), and have a single connector attached (SCA) connector.
- The hard disk drive bays connect to a SCSI *backplane*. This backplane is the printed circuit board behind the bay and is connected to J4 on the system board.
- The backplane controls the SCSI IDs for the hard disk drives.

Preinstallation steps

Before you install a hard disk drive, review the following:

- Inspect the drive tray for any signs of damage.
- Ensure that the drive is installed properly in the tray.
- To maintain proper system cooling, do not operate the server for more than two minutes without either a drive or a filler panel installed in each bay.
- If your server has a ServeRAID adapter installed; refer to the documentation provided with the ServeRAID adapter for information about adding a drive.
- Review the information in “Safety information” on page 37 and “Handling static sensitive devices” on page 36.
- Check the instructions that come with the drive for more information about installing your drive.

Installing or replacing a hard disk drive

Refer to the following illustration to install a hard disk drive.

Note: The illustrations in this document might differ slightly from your hardware.

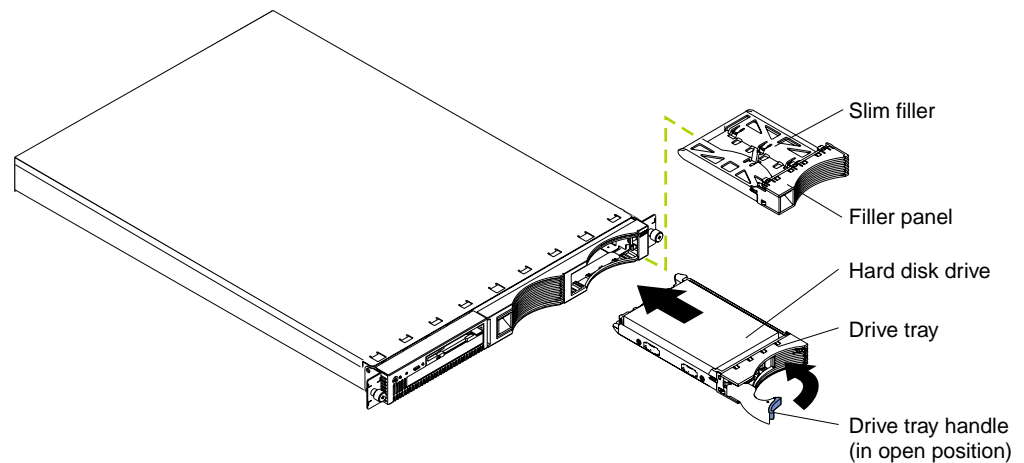

Attention: When you handle electrostatic discharge (ESD) sensitive devices, take precautions to avoid damage from static electricity. For details on handling these devices, refer to “Handling static sensitive devices” on page 36.

Complete the following steps to install or replace a hard disk drive:

1. Review the information in “Safety information” on page 37.
2. If you are installing a non-hot-swap disk drive, turn off the server and all attached devices.
3. Remove the filler panel or defective hard drive from one of the hard disk drive bays.
4. Install the new hard disk drive in the drive bay:
 - a. Ensure the tray handle is open (that is, perpendicular to the drive).
 - b. Align the rails on the drive assembly with the guide rails in the drive bay.
 - c. Gently push the drive assembly into the bay until the drive connects to the backplane.
 - d. Push the tray handle toward the closed position until it locks the drive in place.
5. If you are installing a non-hot-swap disk drive, connect the external cables and power cords; then, turn on the server.
6. Check the hard disk drive status indicators to verify that the hard disk drives are operating properly. (See “Major components of the xSeries 330 server” on page 31 for the location of the status indicators.)
 - The amber light is on continuously, the drive had failed. (Only when a ServeRAID adapter is installed.)
 - The green light flashes slowly (one flash per second), the drive is being rebuilt. (Only when a ServeRAID adapter is installed.)
 - The green light flashes rapidly (three flashes per second), the controller is identifying the drive.

Note: If your server has a ServeRAID adapter installed, you can hot swap drives. For more information about hot swapping drives, refer to the documentation provided with the ServeRAID adapter.

Memory

Adding memory to your server is an easy way to improve system performance. You can increase the amount of memory in your server by installing options called *memory-module kits*. Each kit contains one industry-standard, dual-inline memory module (DIMM). Your server uses a noninterleaved memory configuration, which allows you to add, remove, or replace one DIMM at a time. In an interleaved system you would have to add, remove, or replace memory in sets.

Your server comes with a dual inline memory module (DIMM) installed on the system board in DIMM slot 1.

Note: Install additional DIMMs in the following order: DIMM connector 2, then 3, then 4. (See the following illustration for memory connector locations).

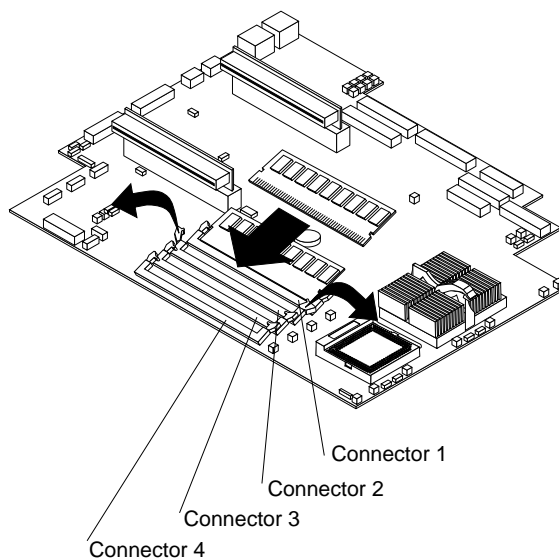

Installing memory modules

Complete the following steps to install a DIMM:

Attention: When you handle electrostatic discharge-sensitive devices (ESD), take precautions to avoid damage from static electricity. For details on handling these devices, refer to “Handling static sensitive devices” on page 36.

1. Review the information in “Safety information” on page 37.
2. Turn off the server and peripheral devices.
3. Remove all external cables from the server; then, remove the server from the rack and remove the cover. For more information see “Removing the cover” on page 43 for instructions.
4. If necessary, remove the PCI card in slot 2 for easier access to the DIMM connectors.
5. Touch the static-protective package containing the DIMM to any unpainted metal surface on the server. Then, remove the DIMM from the package.

Attention: To avoid breaking the retaining clips or damaging the DIMM connectors, handle the clips gently.

6. Install the DIMM in the connector.

Attention: To prevent damage to the DIMM connectors, do not force the memory module into the connector.

- a. Turn the DIMM so that the index slots align correctly with the connector.

Note: The DIMM has two index slots, one in the center and the other on the left half of the DIMM connector edge.

- b. Insert the DIMM into the connector by pressing on both corners of the DIMM at the same time. Be sure to press straight into the connector.
- c. When installing a memory module, be sure that no gap exists between the DIMM and the retaining clips. If a gap does exist between the memory module and the retaining clips, remove the DIMM; then, reinsert the DIMM properly.

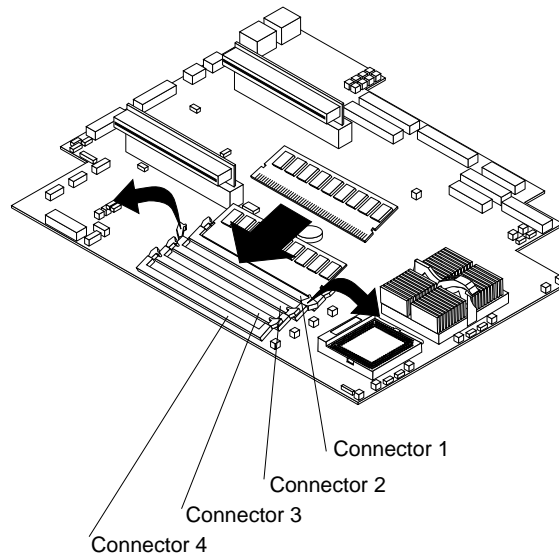

Note: If you have other options to install, install them now.

7. Replace the cover on the server; then, reinstall the server in the rack and connect all external cables. For more information, see “Installing the cover” on page 57 for instructions.

8. Turn on the server.

Attention: When you restart the server, the system displays a message indicating that the memory configuration has changed.

- If you installed additional memory, start the Configuration/Setup Utility program and select Save Settings.
- If you just replaced a failed DIMM, you must start the Configuration/Setup Utility program, select Advanced Setup, select Memory Settings, highlight the connector or bank of connectors that you want to enable, then select Enable.
- In some memory configurations, the 3-3-3 beep code might sound during POST followed by a blank display screen. If this occurs and the Boot Fail Count feature in the Start Options of the Configuration/Setup Utility is set to Enabled (its default setting), you must restart the server three times to force the system BIOS to reset the memory connector or bank of connectors from Disabled to Enabled.

Microprocessor

Your server comes with one or two microprocessors installed on the system board. If you have two, or had one and you installed a second microprocessor, your server can operate as a symmetric multiprocessing (SMP) server. With SMP, certain operating systems and application programs can distribute the processing load between the microprocessors. This enhances performance for database and point-of-sale applications, integrated manufacturing solutions, and other applications.

Notes:

1. Before you install a new microprocessor, review the documentation that comes with the microprocessor, so that you can determine whether you need to update the server basic input/output system (BIOS). The latest level of BIOS for your server is available through the World Wide Web. Refer to “Getting help, service, and information” on page 124 for the appropriate World Wide Web addresses.
2. Obtain an SMP-capable operating system (optional). For a list of supported operating systems, see <http://www.ibm.com/pc/us/compat/> on the World Wide Web.
3. If your server comes with one microprocessor, it is installed in microprocessor connector 1, which is the microprocessor connector closer to the DIMM connectors. This is the startup (boot) microprocessor. If you install a second microprocessor in microprocessor connector 2, the two processors will share the system load after the system has started.

Attention: To avoid damage and ensure proper server operation, install microprocessors that are the same type, have the same cache size, and have the same clock speed. Microprocessor internal clock frequencies and external clock frequencies must be identical. See the ServerProven list at <http://www.ibm.com/pc/compat/> for a list of microprocessors for use with your server.

Note: If you need to replace an existing microprocessor, call for service.

Installing the microprocessor

Complete the following steps to install an additional microprocessor:

Attention: When you handle electrostatic discharge sensitive devices (ESD), take precautions to avoid damage from static electricity. For details on handling these devices, refer to “Handling static sensitive devices” on page 36.

1. Review the information in “Safety information” on page 37.
2. Turn off the server and peripheral devices.
3. Remove all external cables from the server; then, remove the server from the rack and remove the cover. For more information see “Removing the cover” on page 43 for instructions.
4. Remove the clear shield from the server and store it in a safe place.
5. Lift up the microprocessor release lever and remove the terminator card from the microprocessor connector. (After you remove the new microprocessor from the static-protective package, place the terminator card in the bag and store it in a safe place. You will need to install the terminator card again, if you ever remove the microprocessor and do not replace the microprocessor).

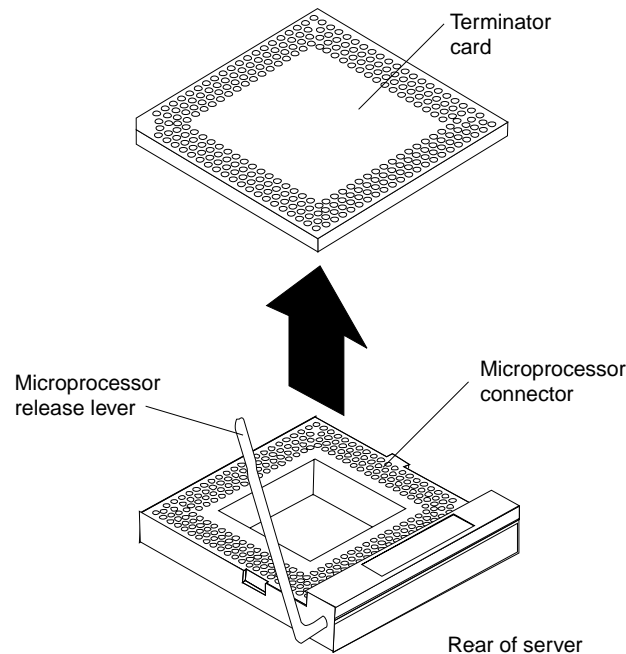

6. Install the microprocessor:
 - a. Touch the static-protective package containing the new microprocessor to any *unpainted* metal surface on the server; then, remove the microprocessor from the package.
 - b. Orient the microprocessor over the microprocessor connector as shown in the following illustration. Carefully press the microprocessor into the connector.

Note: To avoid bending the pins on the microprocessor, do not use excessive force when pressing it into the connector.

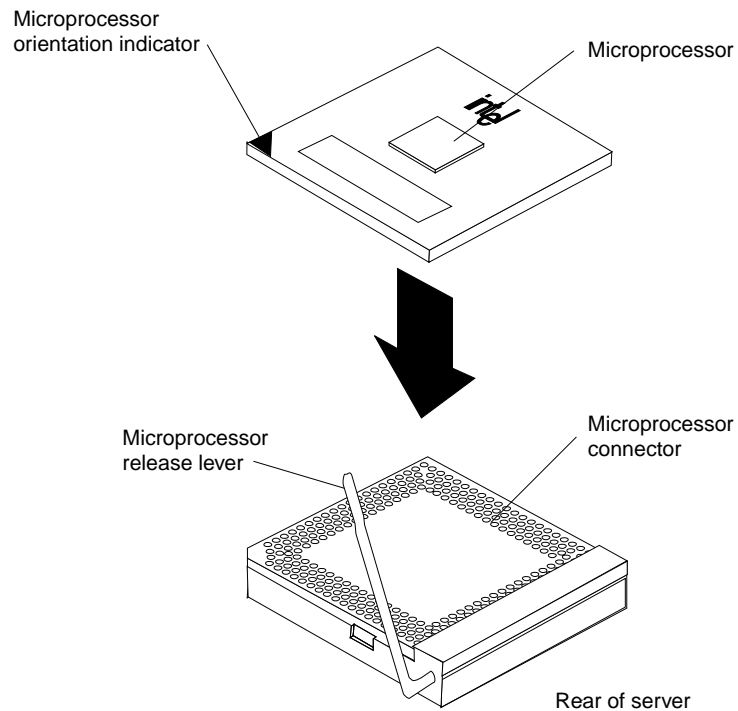

7. Push the microprocessor release lever down to lock the microprocessor in place.
8. Install the heat sink on the microprocessor:
 - a. Peel the plastic protective strip off the bottom of the heat sink. Make sure the square of thermal material is still on the bottom of the heat sink.
 - b. Align and place the heat sink on top of the microprocessor.

Note: Locate the slot in the channel of the heat sink. Orientate the heat sink so the slot will be at the rear of the server.
 - c. Align and place the clip over the heat sink; then, snap the clip into place over the heat sink with the heat sink release lever in the up position.

Note: If you remove the microprocessor later, remember to install the terminator card in the appropriate microprocessor connector.
 - d. Press the heat sink release lever down into the locked position, once the clip is in place.

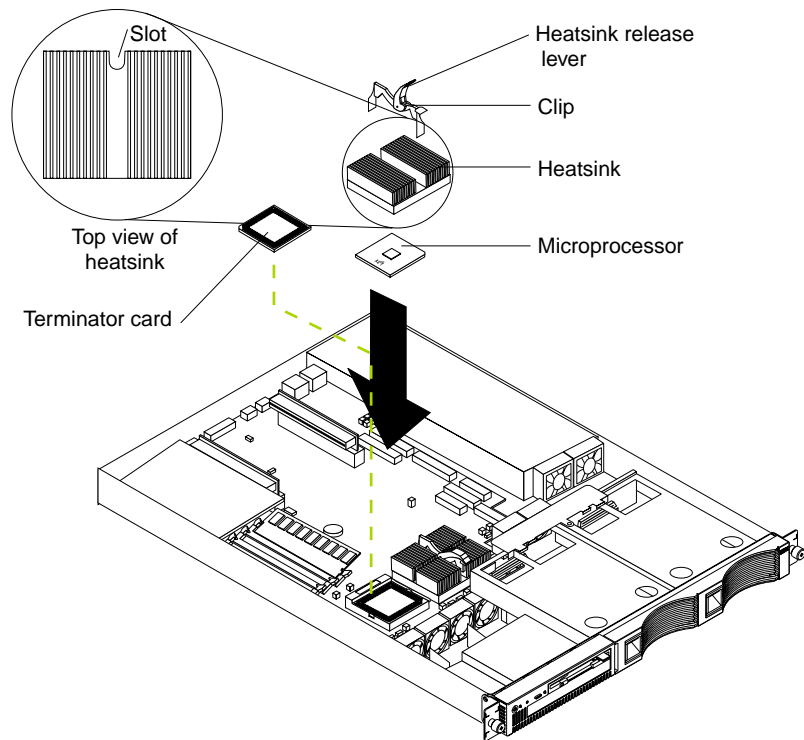

9. Replace the clear shield.

Note: If you need to replace an existing microprocessor, call for service.

10. Replace the cover on the server; then, reinstall the server in the rack and connect all external cables. For more information, see “Installing the cover” on page 57 for instructions.

11. Start the server and run the Configuration/Setup Utility program.

Fan assembly replacement

Your server comes with six replaceable fans.

Attention: Replace a fan that has failed within 48 hours to help ensure proper cooling.

The following illustration shows the replacement of a fan.

Note: The illustrations in this document might differ slightly from your hardware.

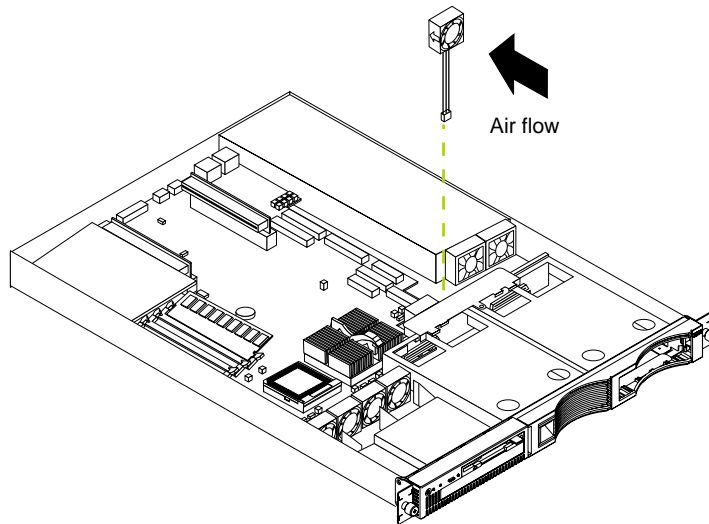

Complete the following steps to replace the fan assembly:

1. Review the information in “Safety information” on page 37.
2. Turn off the server and peripheral devices.
3. Remove all external cables from the server; then, remove the server from the rack and remove the cover. For more information, see “Removing the cover” on page 43 for instructions.
4. Determine which fan to replace by checking the LED at each fan; a lit LED indicates the fan to replace.

Note: The fan LEDs are illuminated by the light path diagnostic circuit, and will remain lit for up to 12 hours after the AC power has been removed from the server.

5. Remove the fan from the server:
 - a. Disconnect the fan cable from the system board.
 - b. Lift the fan away from the server.
6. Orientate the fan so that the air flow arrow on the side of the fan is facing or pointing toward the rear of the server.

Note: Proper air flow is from the front to the rear of the server.
7. Push the replacement fan assembly into the server until it clicks into place.
8. Connect the fan cable to the system board.
9. Replace the cover on the server; then, reinstall the server in the rack and connect all external cables. For more information, see “Installing the cover” on page 57 for instructions.

10. Start up the system, the system error light will either remain on or turn off. If the system error light remains on, you will have to turn off the server to perform further troubleshooting.

Installing the cover

The following information describes the cover installation procedure.

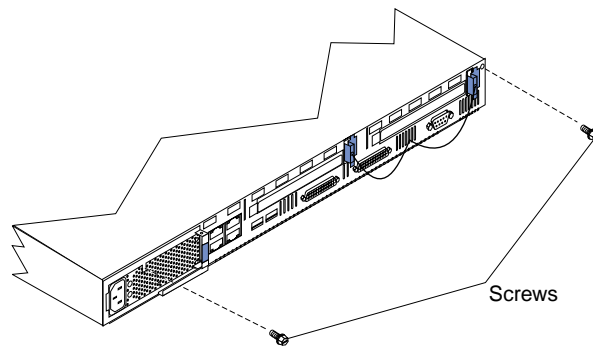

Complete the following to install the server cover:

1. Clear any cables that might impede the replacement of the clear shield or the cover.
2. Install the clear shield, if it was removed.
3. Install the cover by placing it into position and sliding it forward. Make sure the cover engages the tabs at the front and rear of the server.
Attention: Before sliding the cover forward, make sure that all of the tabs on the cover will engage the ledge at the front of the server properly. If all the tabs do not engage the ledge properly, it will be extremely difficult to remove the cover later.
4. Install the screws and secure the cover as shown.
5. Reinstall the server in the rack.
6. Reconnect the power cord and all external cables to the server, then plug the power cords into electrical outlets.

I/O connector locations and ports

The following illustration shows the input/output connectors (ports) and the expansion slots on the rear of the server. For pin assignments and other details about these connectors, see “Input/Output ports”.

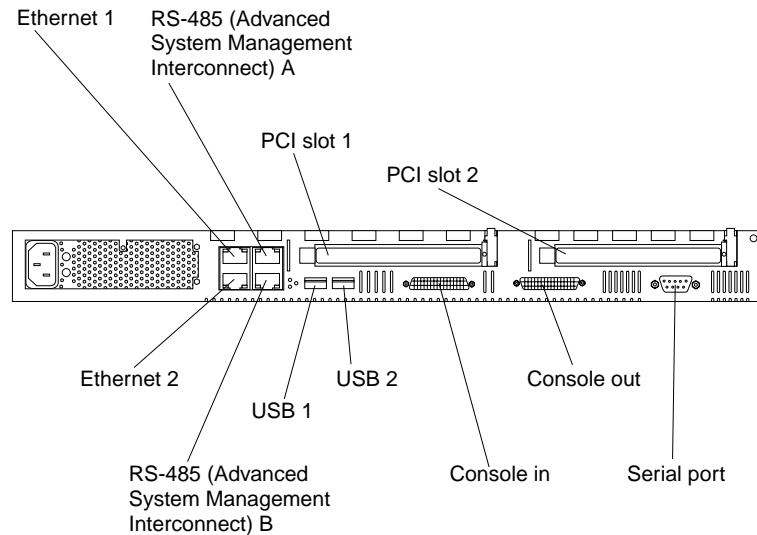

Input/Output ports

This section provides information about the input/output (I/O) ports on your server. These ports include the following:

- Serial port
- Universal Serial Bus (USB) ports
- Console ports
- Ethernet ports
- Advanced System Management (ASM) ports

Serial port

Your server has one standard serial port. Some application programs require specific ports, and some modems function properly only at certain communication port addresses. You might need to use the Configuration/Setup Utility program to change communication port address assignments to prevent or resolve address conflicts. This serial port is also manually configurable from inside of the server. The following table lists the function of each of the connectors which can be used to manually configure the serial port. You will also need to refer to the figure in “System board options connectors” on page 32.

Connectors	Port	Description
J52	Serial A/Systems Management Port	Default connection. Used by OS and Advanced System Management Processor. Modem can be connected so that the system can dial out during problems.
J51	Serial Port B	Used by OS only.
J53	Management Port	Used by Advanced System Management Processor to utilize modem dial up functions.

Table 4. Serial port connectors on the system board

Viewing or changing the serial-port assignments: To view or change the serial-port assignments:

1. Restart the server and watch the monitor screen.
2. When the message Press F1 for Configuration/Setup appears, press F1.
3. From the main menu, select **Devices and I/O Ports**; then, press Enter.
Note: The Devices and I/O Ports choice appears only on the full configuration menu. If you set two levels of passwords, you must enter the administrator password to access the full configuration menu.
4. Select the serial port; then, use the arrow keys to advance through the settings available.
5. Select **Save Settings**; then, select **Exit Setup** to exit from the Configuration/Setup Utility main menu.

Serial-port connector: The following table shows the pin-number assignments for the 9-pin, male D-shell serial-port connector on the rear of your server. These pin-number assignments conform to the industry standard.

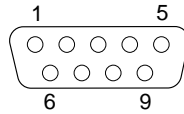

Pin	Signal	Pin	Signal
1	Data carrier detect	6	Data set ready
2	Receive data	7	Request to send
3	Transmit data	8	Clear to send
4	Data terminal ready	9	Ring indicator
5	Signal ground		

Table 5. Serial-port connectors pin-number assignments

Universal Serial Bus ports

Your server has two Universal Serial Bus (USB) ports, which configure automatically. USB is an emerging serial interface standard for telephony and multimedia devices. It uses Plug and Play technology to determine the type of device attached to the connector.

Notes:

1. If you attach a standard (non-USB) keyboard to the keyboard connector, the USB ports and devices will be disabled during the power-on self-test (POST).
2. If you install a USB keyboard that has a mouse port, the USB keyboard emulates a mouse and you will not be able to disable the mouse settings in the Configuration/Setup Utility program.

USB cables and hubs: You need a 4-pin cable to connect devices to USB 1 or USB 2. If you plan to attach more than two USB devices, you must use a hub to connect the devices. The hub provides multiple connectors for attaching additional external USB devices.

USB technology provides up to 12 megabits-per-second (Mbps) speed with a maximum of 127 external devices and a maximum signal distance of five meters (16 ft). per segment.

USB-port connectors: Each USB port has an external connector on the rear of the server for attaching USB compatible devices.

The following table shows the pin-number assignments for the USB-port connectors on the rear of your server.

Pin	Signal
1	VCC
2	-Data
3	+Data
4	Ground

Table 6. USB-port connector pin-number assignments

Console ports

There are two console ports on the rear of your server labeled In and Out. These ports are used to create a console communications chain between servers and a console (monitor, mouse, and keyboard).

Note: The highest video mode supported in the C2T chain is 1024x768.

Connect a C2T console cable from the Console (Out) to the Console (In) connector of another xSeries 330 server, as shown in the following illustration. Connect a C2T device breakout cable to the Console (Out) connector of the last server in the chain; then, connect your monitor, keyboard, and pointing device to the device breakout cable.

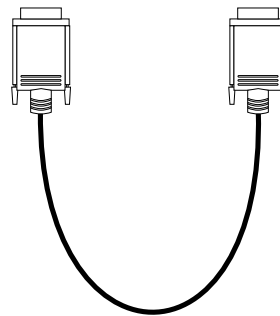

Note: The C2T device breakout cable is available in the C2T cable option kit.

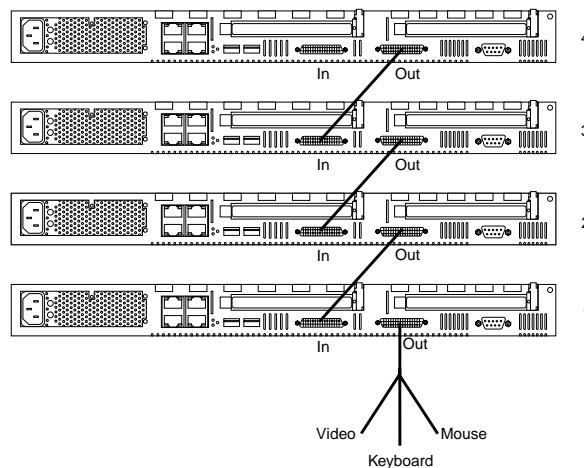

C2T device breakout cable

A keyboard, monitor, and mouse or pointing device are connected to your server through the C2T device breakout cable. The keyboard and mouse cables have icons of a keyboard and a mouse on their respective cable connectors for easy identification.

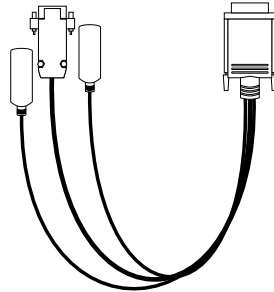

Keyboard connector: There is one keyboard connector on the end of the C2T device breakout cable. This connector is identified by the keyboard icon.

Note: If you attach a standard (non-USB) keyboard to the keyboard connector, the USB ports and devices will be disabled during the power-on self-test (POST).

The following table shows the pin-number assignments for the keyboard connector on the end of the cable.

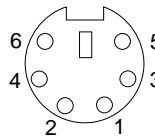

Pin	I/O	Signal
1	I/O	Data
2	N/A	Reserved
3	N/A	Ground
4	N/A	+5 V dc
5	I/O	Keyboard clock
6	N/A	Reserved

Table 7. Keyboard-connector (6-pin female) number assignments

Video connector: The following table shows the pin-number assignments for the 15-pin analog video connector on the end of the C2T device breakout cable. This cable is not labeled but is easily identified by the dark blue 15-pin connector.

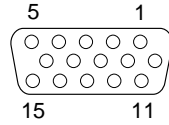

Pin	Signal	Pin	Signal	Pin	Signal
1	Red	6	Ground	11	Not connected
2	Green or monochrome	7	Ground	12	DDC SDA
3	Blue	8	Ground	13	Horizontal synchronization (Hsync)
4	Not connected	9	+5 V dc DDC	14	Vertical synchronization (Vsync)
5	Ground	10	Ground	15	DDC SCL

Table 8. Video-connector (15-pin female) number assignments

Auxiliary-device (pointing device) connector: On the end of the C2T device breakout cable, there is one auxiliary-device connector that supports a mouse or other pointing device. This connector is identified by the mouse icon.

The following table shows the pin-number assignments for the auxiliary-device connector on the end of the cable.

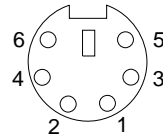

Pin	Signal
1	Data
2	Not connected
3	Ground
4	+5 V dc
5	Clock
6	Not connected

Table 9. Auxiliary or pointing-device-connector (6 pin female) number assignments

Ethernet ports

Your server comes with two integrated Ethernet controllers. These controllers provide an interface for connecting to 10-Mbps or 100-Mbps networks and provide full-duplex (FDX) capability, which enables simultaneous transmission and reception of data on the Ethernet local area network (LAN).

To access the Ethernet ports, connect a Category 3, 4 or 5 unshielded twisted-pair (UTP) cable to the RJ-45 connector on the rear of your server.

Note: The 100BASE-TX Fast Ethernet standard requires that the cabling in the network be Category 5 or higher.

Configuring the Ethernet controllers: When you connect your server to the network, the Ethernet controllers automatically detect the data-transfer rate (10Mbps or 100Mbps) on the network and then set the controllers to operate at the appropriate rate. In addition, if the Ethernet ports that your server is connected to support auto-negotiation, the Ethernet controllers will set the appropriate duplex state. That is, the Ethernet controllers will adjust to the network data rate, whether the data rate is standard Ethernet (10BASE-T), Fast Ethernet (100BASE-TX), half duplex (HDX), or full duplex (FDX). The controllers support half-duplex (HDX) and full-duplex (FDX) modes at both speeds.

The Ethernet controllers are PCI Plug and Play devices. You do not need to set any jumpers or configure the controllers for your operating system before you use the Ethernet controllers. However, you must install a device driver to enable your operating system to address the Ethernet controllers. The device drivers are provided on the ServerGuide CDs.

Failover for redundant Ethernet: The IBM Netfinity 10/100 Ethernet Adapter or the IBM 10/100 Etherjet PCI family of adapters are optional redundant network interface cards (NIC adapter) that you can install in your server. If you install this NIC adapter and connect it to the same logical segment as the primary Ethernet controller, you can configure the server to support a *failover* function. You can configure either one of the integrated Ethernet controllers or the NIC adapter as the primary Ethernet controller. In failover mode, if the primary Ethernet controller detects a link failure, all Ethernet traffic associated with it is switched to the redundant (secondary) controller. This switching occurs without any user intervention. When the primary link is restored to an operational state, the Ethernet traffic switches back to the primary Ethernet controller.

High Performance Ethernet Modes: Your Ethernet controllers support optional modes, such as teaming, priority packets, and virtual LANs, which provide higher performance and throughput for your server.

Teaming Mode: Your Ethernet controllers provide options, called *teaming options*. These options increase throughput and fault tolerance when running with Windows NT 4.0 or NetWare 4.1x or later.

- **Adapter fault tolerance (AFT)** provides automatic redundancy for your adapter. If the primary adapter fails, the secondary adapter takes over. Adapter fault tolerance supports from 2 to 4 adapters per team.
- **Adaptive load balancing (ALB)** allows you to balance the transmission data flow among 2 to 4 adapters. ALB also includes the AFT option. You can use ALB with any 100BASE-TX switch.
- **Cisco Fast EtherChannel (FEC)** creates a team of 2 to 4 adapters to increase transmission and reception throughput. FEC also includes the AFT option. You can only use FEC with a switch that has FEC capability.

Teaming requires you to install both integrated Ethernet controllers. For additional information about the teaming modes, refer to the documentation that comes with these additional adapters.

Priority Packet Mode: Priority Packet is a traffic-prioritization utility that enables you to set up filters to process high-priority traffic before normal traffic. You can send information from critical nodes or applications with an indicated priority. Because you set this priority at the host or entry point of the network, the network devices can base forwarding decisions on priority information defined in the packet.

Priority Packet information is available on the IBM Networking Web site at: <http://www.ibm.com/networking/support>

Priority Packet prioritizes traffic based on priority filters. These are parameters you assign to outgoing (transmit) packets. Using the Priority Filter Wizard, you can set up predefined or custom priority filters based on a node (MAC) address, Ethernet type, or by various properties of the protocol and port. Priority Packet provides two different methods for prioritizing traffic: IEEE 802.1p tagging and High Priority Queue.

IEEE 802.1p is a new IEEE standard for tagging, or adding additional bytes of information to packets with different priority levels. Packets are tagged with 4 additional bytes, which increase the packet size and indicate a priority level. When you send these packets out on the network, the higher priority packets are transferred first. Priority packet tagging (also known as Traffic Class Expediting) allows the adapter to work with other elements of the network (such as switches and routers) to deliver priority packets first. You can assign specific priority levels from 0 (low) to 7 (high).

You can assign values to packets based on their priority when you use the IEEE 802.1p standard for packet tagging. This method requires a network infrastructure that supports packet tagging. The routing devices receiving and transferring these packets on your network must support 802.1p for tagging to be effective.

After you set up the priority filter in Priority Packet, you must launch IBMSet and select **802.1p/802.1Q Tagging** on the Advanced tab.

Note: IEEE 802.1p tagging increases the size of the packets it tags. Some hubs and switches will not recognize the larger packets and will drop them. Check your hub or switch documentation to see if they support 802.1p. (You can configure the switch to strip the tags from the packets and send it on to the next destination as normal traffic). If these devices do not support 802.1p or if you are not sure, use High Priority Queue (HPQ) to prioritize network traffic.

The requirements for effectively using IEEE 802.1p tagging are:

- The other devices receiving and routing 802.1p tagged packets must support 802.1p.
- The adapters on these devices must support 802.1p. The Ethernet controller in your server, all IBM Netfinity 10/100 Ethernet Security Adapters, and IBM 10/100 Ethernet Server Adapters support 802.1p.
- The adapter cannot be assigned to an adapter team.
- If you are setting up VLANs and packet tagging on the same adapter, 802.1p/802.1Q Tagging must be enabled on the IBMSet Advanced tab.

If your network infrastructure devices do not support IEEE 802.1p or you are not sure, you can still define filters and send packets as high priority. While High Priority Queue (HPQ) does not provide the precise priority levels of 802.1p tagging, it does assign traffic as either high or low priority and sends high priority packets first. Therefore, if there are multiple applications on a system sending packets, the packets from the application with a filter are sent out first. HPQ does not change network routing, nor does it add any information to the packets.

To assign HPQ, you can specify it using Priority Packet when you create or assign a filter.

To effectively use HPQ, the adapter cannot be assigned to an adapter team.

Virtual LAN Mode: A virtual LAN (VLAN) is a logical grouping of network devices put together as a LAN, regardless of their physical grouping or collision domains. Using VLANs increases network performance and improves network security.

VLANs offer you the ability to group users and devices together into logical workgroups. This can simplify network administration when connecting clients to servers that are geographically dispersed across the building, campus, or enterprise network.

Normally, VLANs are configured at the switch and any computer can be a member of one VLAN per installed network adapter. Your Ethernet controller supersedes this by communicating directly with the switch, allowing multiple VLANs on a single network adapter (up to 64 VLANs).

To set up VLAN membership, your Ethernet controller must be attached to a switch that has VLAN capability. You also need to use Windows NT 4.0 or later, or Novell NetWare 4.1x or later.

Notes:

1. Windows NT versions prior to 4.0 do not support VLANs.
2. VLANs require NT 4.0 with Service Pack 3.0 and the NDIS driver hotfix from Microsoft.
3. In Windows NT, VLANs cannot be implemented on controllers that have been configured for teaming options. NetWare can support teaming options and VLANs on the same adapters.

To join a VLAN from Windows NT 4.0:

1. Create a VLAN on the switch. Use the parameters you assign there to join the VLAN from the server. Refer to your switch documentation for more information.
2. Double-click the Network icon in the Control Panel window.
3. On the Adapters tab, select the adapter you want to be on the VLAN and select **Properties**.
4. In IBMSet, select **Join VLAN**. Note that VLANs cannot be assigned to adapters that are already defined to have an adapter teaming option.
5. Enter the VLAN ID and VLAN name. The VLAN ID must match the VLAN ID of the switch. The ID range is from 1 to 1000. The VLAN name is for information only and does not need to match the name on the switch.
6. Select **Join VLAN**. Repeat steps 3 through 5 for each VLAN you want the server to join. The VLANs you add are listed on the Adapters tab.
7. Select **Close** and restart the computer.

Ethernet port connector: The following table shows the pin-number assignments for the RJ-45 connector. These assignments apply to both 10BASE-T and 100BASE-TX devices.

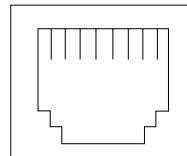

Pin	Signal	Pin	Signal
1	Transmit data+	5	Not connected
2	Transmit data-	6	Receive data -
3	Receive data+	7	Not connected
4	Not connected	8	Not connected

Table 10. Ethernet RJ-45 connector pin-number assignments.

Advanced System Management ports

There are two kinds of Advanced System Management ports: Management port (Serial port A) and RS-485 ports.

Management Port (Serial port A)

This port uses a standard D-shell serial-port connector, labeled A on the rear of the server. You can attach a dedicated modem to the D-shell connector on the rear of your server to communicate with the integrated Advanced System Management Processor. For more information about the serial port, see “Serial port” on page 59.

RS-485 ports

The RS-485 ports on the rear of your server enables you to connect the Advanced System Management Processors of several rack-mounted servers so that they can communicate with each other in half-duplex mode.

Working with cables

Your server has two different cabling options, the Advanced System Management (ASM) bus and the Cable Chain Technology (C2T). The following sections discuss each of these options. While reading about these options, keep in mind that they are independent of each other.

Note: Refer to the following illustration to locate the connectors on the back of your server.

The ASM connectors on the back of the server are referred to in this book as RS-485 (A) and RS-485 (B).

Note: The illustrations in this document might differ slightly from your hardware.

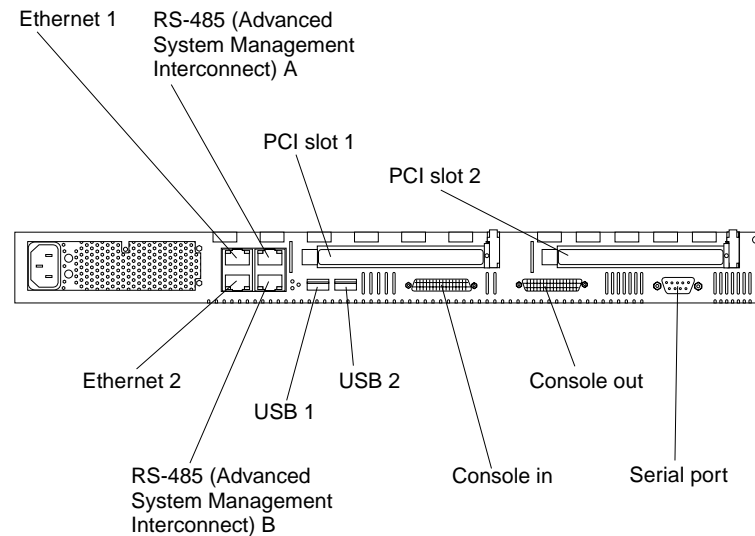

Cabling the RS-485 ports

You can use the RS-485 connectors to create an Advanced System Management (ASM) bus between several xSeries 330 servers or other model servers.

Before you begin, review the following:

Important: The Advanced System Management bus is designed to support up to 12 units or servers. However, when using the Advanced System Management PCI adapter, the bus uses the PCI adapter as another unit. In this case, you can connect a maximum of 11 units or servers together.

- You can hot-swap the cables in the Advanced System Management (ASM) bus.
- You can connect up to 12 units together if you are using serial (management) port A as your Advanced System Management port.
- When connecting an xSeries 330 server to another server type, you must install an Advanced System Management adapter in PCI slot 1 or use the serial port as your Advanced System Management port.
- Use standard cables with RJ-14 connectors.

Note: For more information about the Advanced System Management PCI adapter refer to the documentation that came with the adapter.

Connecting the ASM bus

The servers in the Advanced System Management (ASM) bus are referenced by their assigned addresses and not their position in the rack.

Complete the following steps to connect the ASM bus:

1. Turn off the servers.
2. Locate the RS-485 ports on the rear of the servers and several cables with RJ-14 connectors on both ends.
3. Starting at the top server in the ASM bus, connect one end of the cable into the RS-485 (B) port and the other end of the cable into the RS-485 (A) port of the next server.
4. Continue connecting the servers together in this manner until you reach the second to last server in the ASM bus.
5. Connect a cable from the RS-485 (B) port of the second to last server to the RS-485 (B) port of the last server. Refer to the following illustration to see how to connect the ASM bus.

Note: The illustrations in this document might differ slightly from your hardware.

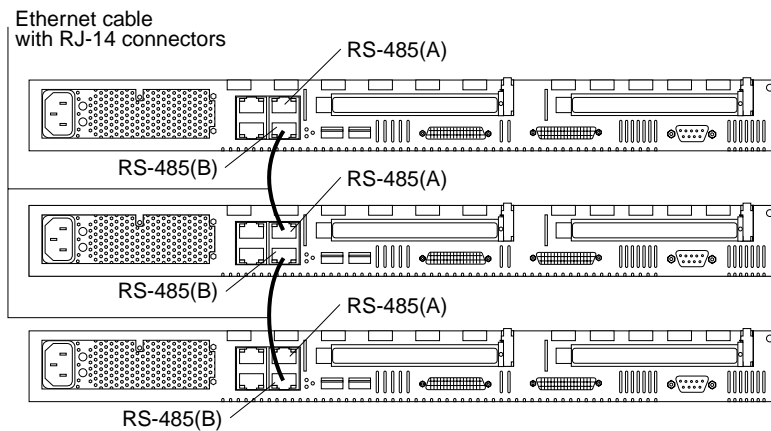

6. Turn on the servers.

Connecting the servers with a C2T chain

To share the same monitor, keyboard, and pointing device with several servers, you must connect the servers together with Cable Chain Technology (C2T) interconnect cables through the Console (In) and Console (Out) ports.

Before you begin, review the following:

- You can connect a maximum of 40 servers with the C2T chaining cables.
- When connecting servers on two separate racks, you must use a C2T interconnect cable that is 2-m (6.5 ft.) long, which is available in the C2T option cable kit.
Note: Only one 2-m (6.5 ft.) cable can be used in the C2T chain.
- The C2T chaining cables are hot-swappable.
Attention: For best results, shut down the servers above and below the server being removed or added.
- Servers are numbered by their position in the chain (1 through nn). If one server is removed from the chain, all successive servers are renumbered. For example, if the twelfth server is removed from a chain of 15 servers, then servers 13 through 15 will then be renumbered to 12 through 14.
- The C2T numbering is independent of any other server reference. Changing the servers position in the C2T chain will not effect their IP addresses.

Operational notes:

1. Server 1 (usually the server at the bottom of the rack) is the server to which you connect the C2T device break out cable.
2. Server 1 must not be turned off (powered down) for the chain to work properly.
3. If server 1 is turned off (powered down), it must be removed from the chain and replaced by the next server in the chain.
4. For the chain to operate properly, no more than two adjacent servers can be unplugged from the wall outlet at the same time.
5. If you are using a flat panel monitor, you might need to adjust the image lock on your monitor when multiple servers are connected using C2T interconnect cables. To adjust this image, select one of the middle servers in the chain by pressing the select button on the front of the server; then, adjust the image lock accordingly. For more information on how to adjust the image lock, refer to the documentation that came with your flat panel monitor.
6. When removing or replacing servers, or changing cables in the chain, it is possible for more than one select LED to be illuminated on the servers in the chain. To clear all but the selected server LED, press the select button on any one of the servers in the chain.
7. If you turn off a selected server, you must select another server that is powered up. For the location of the select button, see page 6.

Complete the following steps to connect the servers:

1. Gather several of the C2T cables.

Note: Your server comes with a short C2T chaining cable that can span approximately 3 U's if needed. A longer C2T cable is available in the C2T cable kit.

2. Connect the servers together:

- a. Connect one end of the C2T chaining cable to the Console (Out) port of the top server.
- b. Connect the opposite end of the C2T chaining cable to the Console (In) port of the server below it. Refer to the following illustration for additional information.
- c. Repeat these steps until all of the servers are connected together.
- d. Connect the C2T device break out cable to the Console (Out) port of server 1.

Note: Server 1 (usually the server at the bottom of the rack) is the server to which you connect the device break out cable.

3. Turn the servers on and check the operation of the monitor, pointing device, and keyboard with each server. (See "Testing the C2T chain" on page 73 for testing instructions).

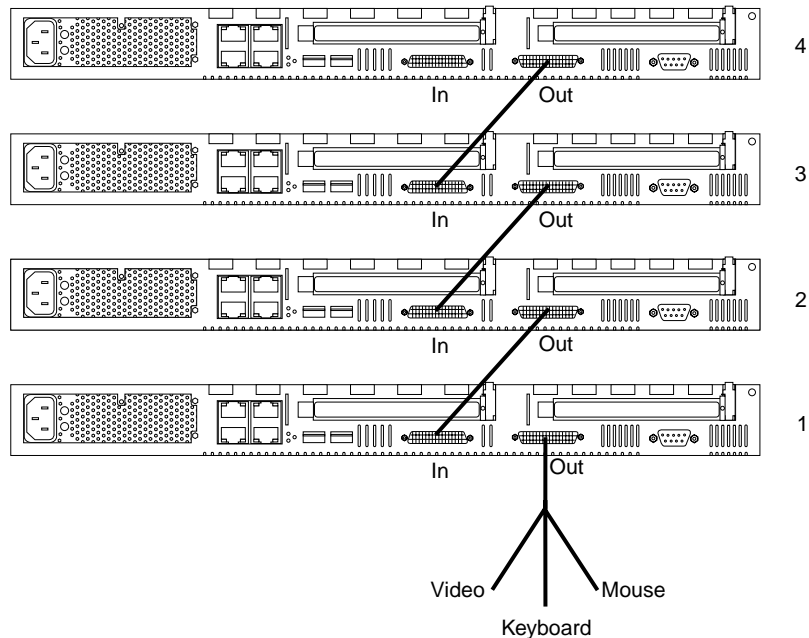

Note: Write-on adhesive labels have been provided so that you can label the servers position in the rack.

Testing the C2T chain

After connecting the C2T chain, you will need to test the monitor, keyboard, and pointing device to be sure that they work with each of the servers.

Follow these steps to test the C2T cabling:

1. With the servers powered up and the monitor on, press the select button on server 1 in the C2T chain.
2. Check the monitor to see if it is working.
3. Use the mouse or pointing device to open an application.
4. Test your keyboard by typing a few words within an application.
5. Repeat steps 1 through 4 for each of the servers in the chain.

Note: If you cannot use the devices, check your cable connections and retry the test. If the problem persists, turn off the servers and connect the C2T device break out cable directly to the Console (Out) port of the server. Power up the server and retry the devices. If the devices work, then you probably have a bad C2T interconnect cable. Replace the cable and retry the devices in the C2T chain configuration.

Cable management

Use the cable ties and hook-and-loop straps that are supplied with your server to secure the cables.

Note: Do not secure cables too tightly. Over tightening can cause internal damage to cables.

Chapter 6. Solving Problems

This section provides basic troubleshooting information to help you resolve some common problems that might occur with your server.

If you cannot locate and correct the problem using the information in this section, refer to “Getting help, service, and information” on page 124 for more information.

Diagnostic tools overview

The following tools are available to help you identify and resolve hardware-related problems:

- **POST beep codes, error messages, and error logs**

The power-on self-test (POST) generates beep codes and messages to indicate successful test completion or the detection of a problem. See “POST” on page 77 for more information.

- **Diagnostic programs and error messages**

The server diagnostic programs are stored in upgradable read-only memory (ROM) on the system board. These programs are the primary method of testing the major components of your server. See “Diagnostic programs and error messages” on page 91 for more information.

- **Light Path Diagnostics**

The Light Path Diagnostics are used to quickly identify system errors.

- **Troubleshooting charts**

These charts list problem symptoms, along with suggested steps to correct the problems. See the “Troubleshooting charts” on page 109 for more information.

- **Customized support page**

You can create a customized support page that is specific to your hardware, complete with Frequently Asked Questions, Parts Information, Technical Hints and Tips, and Downloadable files. In addition, you can choose to receive electronic mail (e-mail) notifications whenever new information becomes available about your registered products.

After you register and profile your xSeries products, you can diagnose problems using the IBM Online Assistant and you can participate in the IBM discussion forum. For more detailed information about registering and creating a customized profile for your IBM products, visit the following addresses on the Web:

- <http://www.ibm.com/pc/register>
- <http://www.ibm.com/pc/support>

Server Support

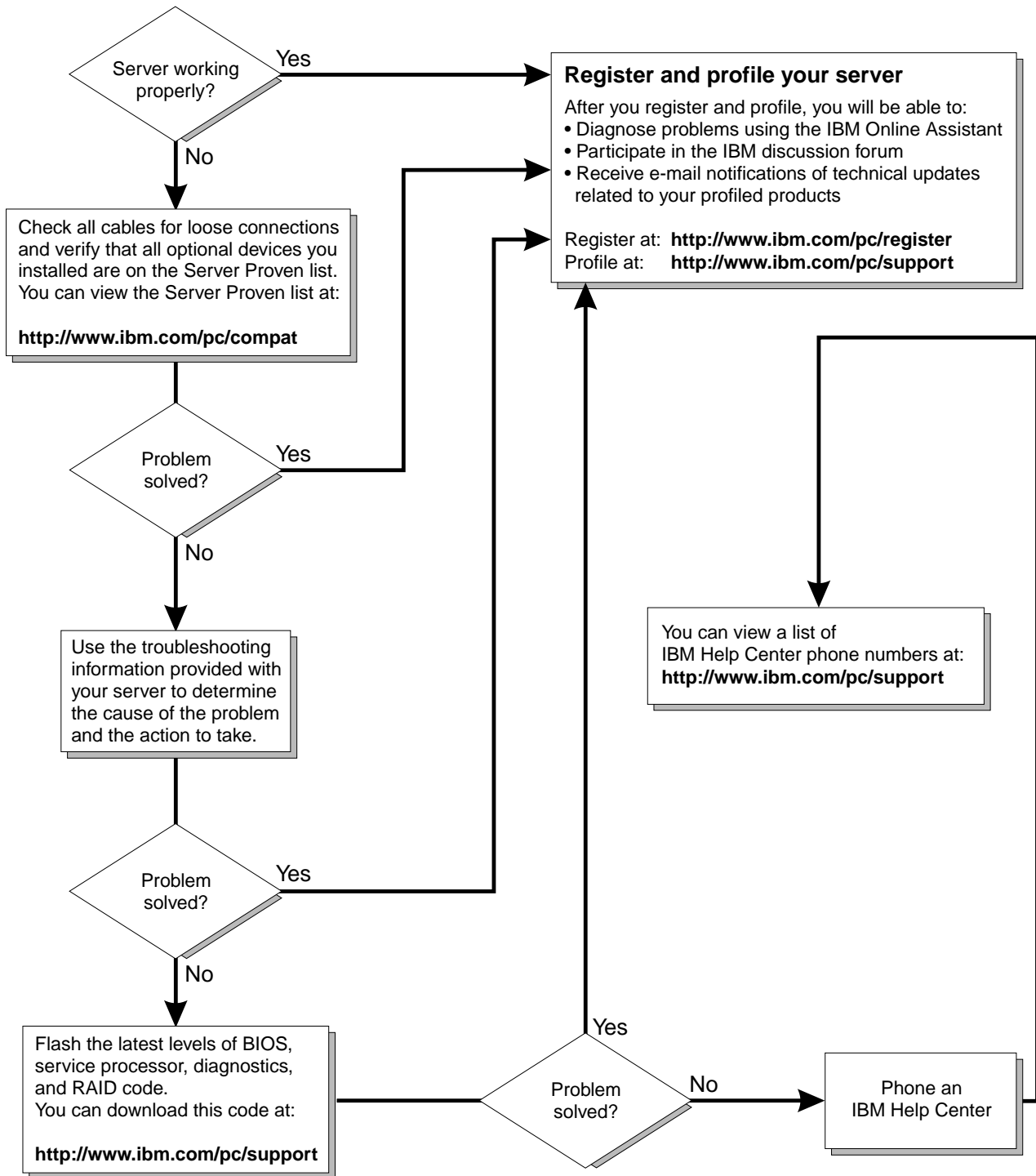

POST

When you turn on the server, it performs a series of tests to check the operation of server components and some of the options installed in the server. This series of tests is called the power-on self-test or POST.

If POST finishes without detecting any problems, a single beep sounds and the first screen of your operating system or application program appears.

If POST detects a problem, more than one beep sounds and an error message appears on your screen. See “POST beep code descriptions” on page 78 and “POST error messages” on page 82 for more information.

Notes:

1. If you have a power-on password set, you must type the password and press Enter, when prompted, before POST will continue.
2. A single problem might cause several error messages. When this occurs, work to correct the cause of the first error message. After you correct the cause of the first error message, the other error messages usually will not occur the next time you run the test.

POST beep code descriptions

Beep codes are sounded in a series of beeps. For example, a 1-2-4 beep code sounds like one beep, a pause, two consecutive beeps, another pause, and four more consecutive beeps.

The possible types of beep codes that your server might emit include the following:

No beeps If no beep occurs after your server completes POST, call for service.

Continuous beep

Your startup (boot) microprocessor has failed, or your system board or speaker subsystem might contain a failing component. If the system continues through POST with no errors, call for service. If no video appears, the startup processor has failed; replace the startup processor.

One short beep

One beep indicates that your server successfully completed POST. POST detected no configuration or functional errors. One beep also occurs after your server completes POST if you enter an incorrect power-on password.

Two short beeps

POST encountered an error. The Configuration/Setup Utility program will display additional information; follow the instructions that appear on the screen. See “POST error messages” on page 82 for descriptions of the text messages that might appear.

Three short beeps

A system memory error has occurred. This combination occurs only if the video Basic Input/Output System (BIOS) cannot display the error message. Replace the failing memory module.

Repeating short beeps

The system board might contain a failing component, your keyboard might be defective, or a key on the keyboard might be stuck. Ensure that:

1. Nothing is resting on the keyboard and pressing a key.
2. No key is stuck.
3. The keyboard cable is connected correctly to the keyboard and to the correct connector on the server.

Running the diagnostic tests can isolate the server component that failed, but you must have your system serviced. If the error message remains, call for service.

Note: If you just connected a new mouse or other pointing device, turn off the server and disconnect that device. Wait at least 5 seconds; then, turn on the server. If the error message goes away, replace the device.

One long and one short beep

POST encountered an error on a video adapter. If you are using the integrated video controller, call for service. If you are using an optional video adapter, replace the failing video adapter.

One long and two short beeps

A video I/O adapter ROM is not readable, or the video subsystem is defective. If you hear this beep combination twice, both the system board and an optional video adapter have failed the test. This beep combination might also indicate that the system board contains a failing component.

One long and three short beeps

The system-board video subsystem has not detected a monitor connection to the server. Ensure that the monitor is connected to the server. If the problem persists, replace the monitor.

Two long and two short beeps

POST does not support the optional video adapter. This beep combination occurs when you install a video adapter that is incompatible with your server. Replace the optional video adapter with one that the server supports or use the integrated video controller.

POST beep codes

Beep code	Description	Action	
1-1-2	Microprocessor register test has failed.	Call for service.	
1-1-3	CMOS write/read test has failed.		
1-1-4	BIOS ROM checksum has failed.		
1-2-1	Programmable Interval Timer test has failed.		
1-2-2	DMA initialization has failed.		
1-2-3	DMA page register write/read test has failed.		
1-4-3	Interrupt vector loading test has failed.		
2-1-1	Secondary DMA register test has failed.		
2-1-2	Primary DMA register test has failed.		
2-1-3	Primary interrupt mask register test has failed.		
2-1-4	Secondary interrupt mask register test has failed.		
2-2-1	Interrupt vector loading has failed.		
2-2-2	Keyboard controller test has failed.		
2-2-3	CMOS power failure and checksum checks have failed.		
2-2-4	CMOS configuration information validation has failed.		
2-3-2	Screen memory test has failed.		
2-3-3	Screen retrace tests have failed.		
2-3-4	Search for video ROM has failed.		
2-4-1	Screen test indicates the screen is operable.		
3-1-1	Timer tick interrupt test has failed.		
3-1-2	Interval timer channel 2 test has failed.		
3-1-3	RAM test has failed above address hex 0FFFF.		
3-1-4	Time-of-Day clock test has failed.		
3-2-1	Serial port test has failed.		
3-2-2	Parallel port test has failed.		
3-2-4	Comparison of CMOS memory size against actual has failed.		
3-3-2	I2C bus has failed.		
2-3-1	Screen initialization has failed.		Turn off the server and then restart the server. If the problem persists, call for service.

Table 11. POST beep codes

1-2-4	RAM refresh verification has failed.	Reseat the memory modules or install a memory module. If the problem persists, call for service.
1-3-1	First 64 Kb RAM test has failed.	
1-3-2	First 64 Kb RAM parity test has failed.	
3-3-1	A memory size mismatch has occurred.	
3-3-3	Attention: In some memory configurations, the 3-3-3 beep code might sound during POST followed by a blank display screen. If this occurs and the Boot Fail Count feature in the Start Options of the Configuration/Setup Utility is set to Enabled (its default setting), you must restart the server three times to force the system BIOS to reset the memory connector or bank of connectors from Disabled to Enabled.	

Table 11. POST beep codes

POST error messages

The following tables provide information about the POST error messages that can appear during startup.

POST message	Description
062	<p>The server failed to boot on three consecutive attempts.</p> <p>All caches are disabled. Repeatedly turning the server on and then off or resetting the server might cause this problem.</p> <p>Action: Start the Configuration/Setup Utility program and verify that all settings are correct. Use the Cache Control selection in the Advanced Setup menu of the Configuration/Setup Utility program to enable the caches.</p> <p>If the problem persists, call for service. When the problem is corrected, be sure to enable the caches.</p>
101 102 106	<p>An error occurred during the system board and microprocessor test.</p> <p>Action: Call for service.</p>
114	<p>An adapter read-only memory (ROM) error occurred.</p> <p>Action: Remove the options. If you can start the server without the options installed, reinstall each option one at a time and retest after each is reinstalled. When an option fails, replace it.</p> <p>If you cannot isolate and correct the problem, call for service.</p>
129	<p>An error was detected in the L1 cache of one of the microprocessors.</p> <p>Action:</p> <ol style="list-style-type: none">1. If you just installed a microprocessor, verify that the microprocessor is installed and seated correctly.2. If the problem persists, call for service.
151	<p>A real-time clock (RTC) error occurred.</p> <p>Action: Call for service.</p>
161	<p>The real-time clock battery has failed.</p> <p>Action: Replace the battery yourself or call for service.</p> <p>You can use the server until you replace the battery. However, you must run the Configuration/Setup Utility program and set the time and date and other custom settings each time you turn on the server.</p>

Table 12. POST error messages

POST message	Description
162	<p>A change in device configuration occurred. This error occurs under one or more of the following conditions:</p> <ul style="list-style-type: none"> • A new device has been installed. • A device has been moved to a different location or cable connection. • A device has been removed or disconnected from a cable. • A device is failing and is no longer recognized by the server as being installed. • An external device is not turned on. • An invalid checksum is detected in the battery-backed memory. <p>Action: Verify that all external devices are turned on. You must turn on external devices before turning on the server.</p> <p>If you did not add, remove, or change the location of a device, a device is probably failing. Running the Diagnostic program might isolate the failing device.</p> <p>If you cannot isolate and correct the problem, call for service.</p>
163	<p>The time of day has not been set.</p> <p>Action: Set the correct date and time. If the date and time are set correctly and saved, but the 163 error message reappears, call for service.</p> <p>You can use the server until the system is serviced, but any application programs that use the date and time will be affected.</p>
164	<p>A change in the memory configuration occurred. This message might appear after you add or remove memory.</p> <p>Note: The server can be used with decreased memory capacity.</p> <p>Action:</p> <ol style="list-style-type: none"> 1. If POST error message 289 also occurred, follow the instructions for that error message first. 2. If you just installed or removed memory, run the Configuration/Setup Utility program; then, exit, saving the new configuration settings. <p>If the message appears again, shut down the server, reseat the memory modules, and restart the server.</p> <p>If the problem persists, call for service.</p>
175	<p>A vital product data (VPD) error occurred.</p> <p>Action: Call for service.</p>
176 177 178	<p>A security hardware error occurred.</p> <p>Action: Check for indications that someone has tampered with the server. If no one has tampered with the server, call for service.</p>
184	<p>The power-on password information stored in your server has been removed.</p> <p>Action: From the Configuration/Setup Utility program main menu, select System Security. Then, follow the instructions on the screen.</p> <p>If this information cannot be restored, call for service.</p>
185	<p>A power failure damaged the stored information about the drive-startup sequence.</p> <p>Action: From the Configuration/Setup Utility program main menu, select Start Options; then, follow the instructions on the screen.</p> <p>If this information cannot be restored, call for service.</p>

Table 12. POST error messages

POST message	Description
186	<p>A system board or hardware error occurred.</p> <p>Action: Call for service.</p>
187	<p>The VPD serial number is not set.</p> <p>Action: The system serial number is set in the VPD EEPROM at the time of manufacturing. If the system board has been replaced, the system serial number will be invalid and should be set. From the main menu of the Configuration/Setup Utility program, select System Information, then select Product Data. If the problem persists, call for service.</p>
188	<p>A vital product data (VPD) error occurred.</p> <p>Action: Call for service.</p>
189	<p>An attempt has been made to access the server with invalid passwords. After three incorrect attempts, the server locks up; that is, the logon data fields are no longer available to the user.</p>
201	<p>An error occurred during the memory controller test. This error can be caused by:</p> <ul style="list-style-type: none"> • Incorrectly installed memory • A failing memory module • A system board problem <p>Action:</p> <ol style="list-style-type: none"> 1. If you just installed memory, verify that the new memory is correct for your server. Also verify that the memory is installed and seated correctly. 2. If the problem persists, call for service.
229	<p>An error was detected in the L2 cache of one of the microprocessors.</p> <p>Action:</p> <ol style="list-style-type: none"> 1. If you just installed a microprocessor, verify that the microprocessor is installed and seated correctly. 2. If the problem persists, call for service.
289	<p>An error occurred during POST memory tests and a failing DIMM was disabled.</p> <p>Note: You can use the server with decreased memory.</p> <p>Action:</p> <ol style="list-style-type: none"> 1. If you just installed memory, verify that the new memory is correct for your server. Also verify that the memory is installed and seated correctly. Start the Configuration/Setup Utility program and select Memory Settings from the Advanced Setup menu to enable the DIMM. 2. If the problem remains, replace the failing DIMM. <p>If the problem persists, call for service.</p>
301 303	<p>An error occurred during the keyboard and keyboard controller test. These error messages also might be accompanied by continuous beeping.</p> <p>Action: Ensure that:</p> <ol style="list-style-type: none"> 1. Nothing is resting on the keyboard and pressing a key. 2. No key is stuck. 3. The keyboard cable is connected correctly to the keyboard and to the correct connector on the server. <p>Running the diagnostic tests can isolate the server component that failed, but you must have your system serviced. If the error message remains, call for service.</p> <p>Note: If you just connected a new mouse or other pointing device, turn off the server and disconnect that device. Wait at least 5 seconds; then, turn on the server. If the error message goes away, replace the device.</p>

Table 12. POST error messages

POST message	Description
602	<p>Invalid diskette boot record</p> <p>Action:</p> <ol style="list-style-type: none"> 1. Replace the diskette. 2. If the problem persists, make sure that the diskette drive cables are correctly and securely connected. 3. If the problem remains, replace the diskette drive. <p>If the problem persists, call for service.</p>
604	<p>An error occurred during a diskette drive test.</p> <p>Action:</p> <ol style="list-style-type: none"> 1. Verify that the Configuration/Setup Utility program correctly reflects the type of diskette drive that you have installed. 2. Run the diagnostic tests. If the diagnostic tests fail, call for service.
662	<p>A diskette drive configuration error occurred.</p> <p>Action: If you removed a diskette drive, make sure that the diskette drive setting is correct in the Configuration/Setup Utility program. If the setting is not correct, change it.</p> <p>If the problem persists, call for service.</p>
962	<p>A parallel port configuration error occurred.</p> <p>Action: If you changed a hardware option, make sure that the parallel port setting is correct in the Configuration/Setup Utility program. If the setting is not correct, change it.</p> <p>If the problem persists, call for service.</p>
11xx	<p>An error occurred during the system-board serial port test.</p> <p>Action: If you have a modem, serial printer, or other serial device attached to your server, verify that the serial cable is connected correctly. If it is, use the following procedure:</p> <ol style="list-style-type: none"> 1. Turn off the server. 2. Disconnect the serial cable from the serial port. 3. Wait five seconds; then, turn on the server. <p>If the POST error message does not reappear, either the serial cable or the device is probably failing. See the documentation that comes with the serial device for additional testing information.</p> <p>If the POST error message reappears, call for service.</p>
1162	<p>The serial port configuration conflicts with another device in the system.</p> <p>Action:</p> <ol style="list-style-type: none"> 1. Make sure the IRQ and I/O port assignments needed by the serial port are available. 2. If all interrupts are being used by adapters, you might need to remove an adapter to make an interrupt available to the serial port, or force other adapters to share an interrupt.
1600	<p>The Advanced System Management processor is not functioning.</p> <p>Action:</p> <ol style="list-style-type: none"> 1. Verify that the jumpers for the system-management processor are set correctly. 2. Disconnect the server from all electrical sources, wait for 30 seconds, reconnect the server to the electrical sources, and restart the server. <p>If the problem persists, call for service.</p>
1601	<p>An Advanced System Management Flash update is needed.</p> <p>Action: Download and install the latest Advanced System Management flash update.</p>

Table 12. POST error messages

POST message	Description
1800	<p>A PCI adapter has requested a hardware interrupt that is not available.</p> <p>Action:</p> <ol style="list-style-type: none"> 1. Make sure that the PCI adapter and all other adapters are set correctly in the Configuration/Setup Utility program. If the interrupt resource settings are not correct, change the settings. 2. If all interrupts are being used by other adapters, you might need to remove an adapter to make an interrupt available to the PCI adapter, or force other adapters to share an interrupt.
1962	<p>No valid startup devices were found. The system cannot find the startup drive or operating system.</p> <p>Action:</p> <p>Be sure that the drive you want to start from is in the startup sequence.</p> <ol style="list-style-type: none"> 1. Select Start Options from the Configuration/Setup Utility program main menu. If you are unable to set the startup sequence, call for service. 2. Check the list of startup devices in the Startup device data fields. Is the drive you want to start from in the startup sequence? <ul style="list-style-type: none"> Yes Exit from this screen; then, select Exit Setup to exit the Configuration/Setup menu. Go to step 3.. No Follow the instructions on the screen to add the drive; then, save the changes and exit the Configuration/Setup menu. Restart the server. 3. Is an operating system installed? <ul style="list-style-type: none"> Yes Turn off the server. Go to step 4.. No Install the operating system in your server; then, follow your operating system instructions to shut down and restart the server. 4. During server startup, watch for messages indicating a hardware problem. <p>If the same error message appears, call for service.</p>
2400	<p>An error occurred during the testing of the video controller on the system board. This error can be caused by a failing monitor, a failing system board, or a failing video adapter (if one is installed).</p> <p>Action: Verify that the monitor is connected correctly to the video connector. If the monitor is connected correctly, call for service.</p>
2462	<p>A video memory configuration error occurred.</p> <p>Action: Make sure that the monitor cables are correctly and securely connected to the server.</p> <p>If the problem persists, call for service.</p>
5962	<p>An IDE CD-ROM configuration error occurred.</p> <p>Action: Check the signal and power cable connections to the CD-ROM drive.</p> <p>If the problem persists, call for service.</p>

Table 12. POST error messages

POST message	Description
8603	<p>An error occurred during the mouse (pointing device) controller test. The addition or removal of a mouse, or a failing system board can cause this error.</p> <p>Note: This error also can occur if electrical power was lost for a very brief period and then restored. In this case, turn off the server for at least 5 seconds; then, turn it back on.</p> <p>Action: Ensure that the keyboard and mouse (pointing device) are attached to the correct connectors. If they are connected correctly, use the following procedure:</p> <ol style="list-style-type: none"> 1. Turn off the server. 2. Disconnect the mouse from the server. 3. Turn on the server. <p>If the POST error message does not reappear, the mouse is probably failing. See the documentation that comes with the mouse for additional testing information. If the problem remains, replace the mouse or pointing device.</p> <p>If the POST error message reappears, run the diagnostic tests to isolate the problem. If the diagnostic tests do not find a problem and the POST error message remains, call for service.</p>
00012000	<p>Processor machine check.</p> <p>Action:</p> <ol style="list-style-type: none"> 1. Update the system BIOS. 2. If the problem persists, replace the microprocessor.
00019501	<p>Processor 1 is not functioning.</p> <p>Action: Replace microprocessor 1.</p> <p>If the problem persists, call for service.</p>
00019502	<p>Processor 2 is not functioning.</p> <p>Action: Replace microprocessor 2.</p> <p>If the problem persists, call for service.</p>
00019701	<p>Processor 1 failed the built-in self test.</p> <p>Action: Replace microprocessor 1.</p> <p>If the problem persists, call for service.</p>
00019702	<p>Processor 2 failed the built-in self-test.</p> <p>Action: Replace microprocessor 2.</p> <p>If the problem persists, call for service.</p>
00180100	<p>A PCI adapter has requested memory resources that are not available</p> <p>Action:</p> <ol style="list-style-type: none"> 1. Make sure that the PCI adapter and all other adapters are set correctly in the Configuration/Setup Utility program. If the memory resource settings are not correct, change the settings. 2. If all memory resources are being used, you might need to remove an adapter to make memory available to the PCI adapter. Disabling the adapter BIOS on the adapter might correct the error. Refer to the documentation provided with the adapter.

Table 12. POST error messages

POST message	Description
00180200	<p>A PCI adapter has requested an I/O address that is not available, or the PCI adapter might be defective.</p> <p>Action:</p> <ol style="list-style-type: none"> 1. Make sure that the I/O address for the PCI adapter and all other adapters are set correctly in the Configuration/Setup Utility program. 2. If the I/O port resource settings are correct, the PCI adapter might be defective. Call for service.
00180300	<p>A PCI adapter has requested a memory address that is not available, or the PCI adapter might be defective.</p> <p>Action:</p> <ol style="list-style-type: none"> 1. Make sure that the memory address for all other adapters are set correctly in the Configuration/Setup Utility program. If the memory resource settings are not correct, change the settings. 2. If the memory resource settings are correct, the PCI adapter might be defective. Call for service.
00180400	<p>A PCI adapter has requested a memory address that is not available.</p> <p>Action: If all memory addresses are being used, you might need to remove an adapter to make memory address space available to the PCI adapter. Disabling the adapter BIOS on the adapter might correct the error. Refer to the documentation provided with the adapter.</p>
00180500	<p>A PCI adapter ROM error occurred.</p> <p>Action: Remove the PCI adapters. If you can start the server without the adapters, reinstall each adapter one at a time and retest after each is reinstalled. When an adapter fails, replace it.</p> <p>If you cannot isolate and correct the problem, call for service.</p>
00180600	<p>A PCI-to-PCI bridge error occurred. More than one PCI bus tried to access memory below 1 MB.</p> <p>Action: Remove the PCI adapter that has the PCI bridge. If you can start the server without the adapter, reinstall and retest the adapter. If the adapter fails, replace it.</p> <p>If you cannot isolate and correct the problem, call for service.</p>
00180700	<p>xxxxyyyy Planar PCI device does not respond or disabled by user. (Where xxxx is the PCI vendor ID and yyyy is the PCI device ID.)</p> <p>Action: Start the Configuration/Setup Utility program, select Devices and I/O Ports, and make sure that the device is enabled. If the problem persists, call for service.</p>
00180800	<p>An unsupported PCI device is installed.</p> <p>Action: Remove the PCI adapters. If you can start the server without the adapters, reinstall each adapter one at a time and retest after each is reinstalled. When an adapter fails, replace it.</p> <p>If the problem persists, call for service.</p>
00181000	<p>PCI error.</p> <p>Action: Remove the PCI adapters. If you can start the server without the adapters, reinstall each adapter one at a time and retest after each is reinstalled. When an adapter fails, replace it.</p> <p>If the problem persists, call for service.</p>
01295085	<p>The ECC checking hardware test failed.</p> <p>Action: Call for service.</p>

Table 12. POST error messages

POST message	Description
01298001	No update data is available for processor 1. Action: Update the system BIOS to a level that supports the microprocessors installed in the server.
01298002	No update data is available for processor 2. Action: Update the system BIOS to a level that supports the microprocessors installed in the server.
01298101	The update data for processor 1 is incorrect. Action: Update the system BIOS to a level that supports the microprocessors installed in the server.
01298102	The update data for processor 2 is incorrect. Action: Update the system BIOS to a level that supports the microprocessors installed in the server.
01298200	Microprocessor speed mismatch Action: The microprocessors installed do not run at the same speed; install microprocessors with identical speeds.
19990301	A hard disk drive error occurred. Action: Call for service.
19990305	POST could not find an operating system. Action: Install an operating system. If you have already installed the operating system, check the drive startup sequence. If the drive sequence is correct, run the diagnostic tests to verify that the hard disk drive is functioning correctly. If there is a problem with the hard disk drive (such as a bad sector), you might need to reinstall the operating system. If you cannot reinstall the operating system, call for service.
19990650	AC power has been restored. Action: No action is required. This message appears each time AC power is restored to the server after an AC power loss.
Other Numbers	POST found an error. Action: Follow the instructions on the screen.

Table 12. POST error messages

Event/error logs

The POST error log contains the three most recent error codes and messages that the system generated during POST. The System Event/Error log contains all messages issued during POST and all system status messages from the Advanced System Management Processor.

To view the contents of this error log, start the Configuration/Setup Utility program; then, select **Event/Error Logs** from the main menu.

Small computer system interface messages

The following table lists actions to take if you receive a SCSI error message.

Note: If your server does not have a hard disk drive, ignore any message that indicates that the BIOS is not installed.

You will get these messages only when running the SCSISelect Utility.

Table 13. SCSI messages

SCSI Messages	Description
All	<p>One or more of the following might be causing the problem.</p> <ul style="list-style-type: none">• A failing SCSI device (adapter, drive, controller)• An improper SCSI configuration• Duplicate SCSI IDs in the same SCSI chain• An improperly installed SCSI terminator• A defective SCSI terminator• An improperly installed cable• A defective cable <p>Action:</p> <p>Verify that:</p> <ul style="list-style-type: none">• The external SCSI devices are turned on. External SCSI devices must be turned on <i>before</i> the server.• The cables for all external SCSI devices are connected correctly.• The last device in each SCSI chain is terminated properly.• The SCSI devices are configured correctly. <p>If the above items are correct, run the diagnostic programs to obtain additional information about the failing device. If the error remains or recurs, call for service.</p>

Diagnostic programs and error messages

The server diagnostic programs are stored in upgradable read-only memory (ROM) on the system board. These programs are the primary method of testing the major components of your server.

Diagnostic error messages indicate that a problem exists; they are not intended to be used to identify a failing part. Troubleshooting and servicing of complex problems that are indicated by error messages should be performed by trained service personnel.

Sometimes the first error to occur causes additional errors. In this case, the server displays more than one error message. Always follow the suggested action instructions for the *first* error message that appears.

The following sections contain the error codes that might appear in the detailed test log and summary log when running the diagnostic programs.

The error code format is as follows:

fff-ttt-iii-date-cc-text message

where:

fff	is the three-digit function code that indicates the function being tested when the error occurred. For example, function code 089 is for the microprocessor.
ttt	is the three-digit failure code that indicates the exact test failure that was encountered. (These codes are for trained service personnel and are described in the <i>Hardware Maintenance Manual</i> .)
iii	is the three-digit device ID. (These codes are for trained service personnel and are described in the <i>Hardware Maintenance Manual</i> .)
date	is the date that the diagnostic test was run and the error recorded.
cc	is the check digit that is used to verify the validity of the information.
text message	is the diagnostic message that indicates the reason for the problem.

Text messages

The diagnostic text message format is as follows:

Function Name: Result (test specific string)

where:

Function Name

is the name of the function being tested when the error occurred. This corresponds to the function code (fff) given in the previous list.

Result can be one of the following:

Passed This result occurs when the diagnostic test completes without any errors.

Failed This result occurs when the diagnostic test discovers an error.

User Aborted

This result occurs when you stop the diagnostic test before it is complete.

Not Applicable

This result occurs when you specify a diagnostic test for a device that is not present.

Aborted This result occurs when the test could not proceed because of the system configuration.

Warning This result occurs when a possible problem is reported during the diagnostic test, such as when a device that is to be tested is not installed.

Test Specific String

This is additional information that you can use to analyze the problem.

Starting the diagnostic programs

You can press F1 while running the diagnostic programs to obtain Help information. You also can press F1 from within a help screen to obtain online documentation from which you can select different categories. To exit Help and return to where you left off, press Esc.

To start the diagnostic programs:

1. Turn on the server and watch the screen.
2. When the message F2 for Diagnostics appears, press F2.
3. Type in the appropriate password; then, press Enter.
4. Select either **Extended** or **Basic** from the top of the screen.
5. When the Diagnostic Programs screen appears, select the test you want to run from the list that appears; then, follow the instructions on the screen.

Notes:

- a. If the server stops during testing and you cannot continue, restart the server and try running the diagnostic programs again. If the problem persists, call for service.
- b. The keyboard and mouse (pointing device) tests assume that a keyboard and mouse are attached to the server.
- c. If you run the diagnostic programs with no mouse attached to your server, you will not be able to navigate between test categories using the **Next Cat** and **Prev Cat** buttons. All other functions provided by mouse-selectable buttons are also available using the function keys.
- d. You can test the USB keyboard by using the regular keyboard test. The regular mouse test can test a USB mouse. Also, you can run the USB hub test only if there are no USB devices attached.
- e. You can view server configuration information (such as system configuration, memory contents, interrupt request (IRQ) use, direct memory access (DMA) use, device drivers, and so on) by selecting **Hardware Info** from the top of the screen.

When the tests have completed, you can view the Test Log by selecting **Utility** from the top of the screen.

If the hardware checks out OK but the problem persists during normal server operations, a software error might be the cause. If you suspect a software problem, refer to the information that comes with the software package.

Viewing the test log

The test log will not contain any information until after the diagnostic program has run.

Note: If you already are running the diagnostic programs, begin with step 3..

To view the test log:

1. Turn on the server and watch the screen.
If the server is on, shut down your operating system and restart the server.
2. When the message F2 for Diagnostics appears, press F2.
If a power-on password is set, the server prompts you for it. Type in the appropriate password; then, press Enter.
3. When the Diagnostic Programs screen appears, select **Utility** from the top of the screen.
4. Select **View Test Log** from the list that appears; then, follow the instructions on the screen.

The system maintains the test-log data while the server is powered on. When you turn off the power to the server, the test log is cleared.

Diagnostic error message tables

The following tables provide descriptions of the error messages that might appear when you run the diagnostic programs.

Attention: If diagnostic error messages appear that are not listed in the following tables, make sure that your server has the latest levels of BIOS, ServeRAID, and diagnostics microcode installed.

Code	Function	Result	Text message	Action
001	Core system	Failed	Processor board, ECC Test	Call for service.
			System board	
005	Video port		Processor and system boards	
011	Serial port		Integrated serial port	
014	Parallel port		Integrated parallel port	
015	USB interface	Aborted	Can NOT test USB interface while it is in use. Note: If you have a USB keyboard or mouse attached, you cannot run the diagnostic program for the USB interface.	<ol style="list-style-type: none"> 1. Turn off the server. 2. Replace the USB keyboard and mouse with a standard keyboard and mouse. 3. Turn on the server. 4. Run the diagnostic test again.
		Failed	System board	Call for service.
020	PCI interface	Failed	System board	Call for service.
030	SCSI interface	Failed	SCSI adapter in slot <i>n</i> failed register/counter/ power test (where <i>n</i> is the slot number of the failing adapter)	Refer to the information provided with the adapter for instructions. If the problem persists, call for service.
			SCSI controller on system board failed register/counter/power test	Call for service.

Table 14. Diagnostic error messages

Code	Function	Result	Text message	Action
035	ServeRAID	Aborted	Test setup error: No ServeRAID adapter found on system board or PCI bus	Make sure the ServeRAID adapter is properly installed. If the problem remains, replace the ServeRAID adapter. If the problem persists, call for service.
		Failed	Adapter in slot <i>n</i> ; adapter/drive configuration error (where <i>n</i> is the slot number of the failing adapter)	Run the ServeRAID Configuration Utility.
			Adapter in slot <i>n</i> ; internal error (where <i>n</i> is the slot number of the failing adapter)	If the problem remains, replace the ServeRAID adapter in slot <i>n</i> .
			Logical drive <i>m</i> on adapter in slot <i>n</i> (where <i>m</i> is the number of the failing logical drive and <i>n</i> is the slot number of the adapter)	If the problem persists, call for service.
			On system board; internal error	Run the ServeRAID Configuration Utility.
			On system board; adapter/drive configuration error	
			Logical drive on system board adapter	If the problem persists, call for service.
			Adapter in slot <i>n</i> ; memory allocation error (where <i>n</i> is the slot number of the failing adapter)	Call for service.
			On system board; memory allocation error	
			On system board; PCI configuration error	
			On system board; POST error	
			Adapter in slot <i>n</i> ; POST error (where <i>n</i> is the slot number of the failing adapter)	Replace the ServeRAID adapter in slot <i>n</i> . If the problem persists, call for service.
			Adapter in slot <i>n</i> ; PCI configuration error (where <i>n</i> is the slot number of the failing adapter)	
			SCSI drive on adapter in slot <i>n</i> , SCSI ID <i>m</i> (where <i>n</i> is the slot number of the adapter and <i>m</i> is the SCSI ID of the drive)	Check the cable and power connections on the drive. If the problem persists, call for service.
075	Power supply	Failed	Voltage sensed by the system is out of range	Call for service.

Table 14. Diagnostic error messages

Code	Function	Result	Text message	Action
089	Microprocessor	Failed	Invalid microprocessor in slot xyz or BIOS setup problem (where xyz identifies the microprocessor that is causing the error message)	<ol style="list-style-type: none"> 1. Check the system error log for the related error messages. 2. If your server does not have the latest level BIOS installed, update the BIOS. 3. If the problem remains, replace the xyz microprocessor and run the test again.
			Processor in socket id xyz is installed but not functioning (where xyz identifies the microprocessor that is causing the error message)	
			Microprocessor in socket id xyz (where xyz identifies the microprocessor that is causing the error message)	<ol style="list-style-type: none"> 1. Reseat the microprocessor. 2. If the problem remains, replace the microprocessor.
			Processor in socket id xyz is defective (where xyz identifies the microprocessor that is causing the error message)	<p>Replace the microprocessor.</p> <p>If the problem persists, call for service.</p>
			Test setup error: Application microprocessor not installed or BIOS setup problem	<ol style="list-style-type: none"> 1. Verify that the Application microprocessor is installed and seated correctly. 2. If your server does not have the latest level BIOS installed, update the BIOS. 3. If the problem remains, replace the application microprocessor and run the test again. <p>If the problem persists, call for service.</p>

Table 14. Diagnostic error messages

Code	Function	Result	Text message	Action
	Microprocessor	Failed	VRM corresponding to Microprocessor in socket <i>xyz</i> is defective (where <i>xyz</i> identifies the microprocessor whose VRM is causing the error message)	Replace the VRM. If the problem remains, call for service.
			VRM corresponding to Microprocessor in socket id <i>xyz</i> is not installed (where <i>xyz</i> identifies the microprocessor whose VRM is causing the error message)	Install a VRM. If the problem persists, call for service.
175	System thermal	Failed	Fan # <i>n</i> (where <i>n</i> is the number of the failing fan)	Replace the indicated fan.
			Temperature sensed on processor board is out of range	Call for service.
180	Status display	Failed	Any failure message	Call for service.
201	System memory	Failed	DIMMs in location DIMM <i>n</i> (where <i>n</i> is the number of the socket that contains the failing DIMM)	<ol style="list-style-type: none"> 1. Reseat the failing DIMM. 2. If the problem remains, replace the DIMM. <p>If the problem persists, call for service.</p>
			Test setup error: Corrupt BIOS in ROM	<p>If your server does not have the latest level BIOS installed, update the BIOS to the latest level.</p> <p>If the problem persists, call for service.</p>
			Test setup error: Corrupt DMI BIOS, information in BIOS is not as expected	

Table 14. Diagnostic error messages

Code	Function	Result	Text message	Action
202	System cache	Aborted	Test setup error: BIOS cannot access VPD information	<p>If your server does not have the latest level BIOS installed, update the BIOS to the latest level and run the diagnostic program again.</p> <p>If the problem persists, call for service.</p>
			Test setup error: Corrupt DMI BIOS. Information in BIOS is not as expected	
			Test setup error: No L2 cache detected on microprocessor socket id xyz or BIOS setup problem (where xyz identifies the microprocessor that is causing the error message)	
		Test setup error: Unknown hardware problem associated with microprocessor in socket id xyz. (where xyz identifies the microprocessor that is causing the error message)	<ol style="list-style-type: none"> 1. If your server does not have the latest level BIOS installed, update the BIOS to the latest level 2. Run the diagnostic program again. 3. If the problem remains, replace the failing processor. <p>If the problem persists, call for service.</p>	
		Failed	Microprocessor in socket ID xyz (where xyz identifies the microprocessor that is causing the error message)	<ol style="list-style-type: none"> 1. Reseat the identified microprocessor. 2. If the problem remains, replace the microprocessor. <p>If the problem persists, call for service.</p>
		Warning	Test setup error: Cache is disabled. Use system setup to enable before retrying the test	<p>Use the Cache Control choice from the Advanced Setup menu to enable the cache.</p> <p>If the problem persists, call for service.</p>
206	Diskette drive	Failed	Internal diskette drive bay	Call for service.
215	CD-ROM	Failed	On system board.	Call for service.
		Aborted	The CD-ROM drive is not present.	Verify that the cables are properly connected to the CD-ROM. If the problem persists, call for service.
217	Hard disk drive	Failed	BIOS drive # n (where n is the drive bay number)	Call for service.

Table 14. Diagnostic error messages

Code	Function	Result	Text message	Action
264	Magnetic tape drive	Aborted	Test setup error: No tape drive found	<p>Check the cable and power connections to the drive.</p> <p>Refer to the information that is provided with the tape drive.</p> <p>If the problem persists, call for service.</p>
		Failed	The load/mount test failed for device n on adapter m (where n is the number of the device and m is the adapter number)	Refer to the information provided with the tape drive.
			The Self-diagnostic failed for device n on adapter m . (where n is the number of the device and m is the adapter number)	If the problem persists, call for service.
			The unload/eject test failed for device n on adapter m (where n is the number of the device and m is the adapter number)	Note: The push button test is applicable only to SCSI tape drives that have a push button.
			The unload/eject push button test failed for device n on adapter m (where n is the number of the device and m is the adapter number)	
			The Read/Write Self-diagnostic failed for device n on adapter m (where n is the number of the device and m is the adapter number)	

Table 14. Diagnostic error messages

Code	Function	Result	Text message	Action
301	Keyboard	Failed	On system board keyboard test failed	<ol style="list-style-type: none"> 1. Verify that the keyboard cable is connected. 2. If the problem remains, replace the keyboard cable. <p>If the problem persists, call for service.</p>
302	Mouse	Failed	On system board pointing device test failed.	Replace the pointing device. If the problem persists, call for service.
305	Video monitor		Any message	Refer to the information that came with the monitor.
405	Ethernet	Failed	In PCI slot <i>n</i> (where <i>n</i> is the PCI slot number in which the failing Ethernet adapter is installed)	Replace the Ethernet adapter in slot <i>n</i> . If the problem persists, call for service.
			On system board	Call for service.

Table 14. Diagnostic error messages

Code	Function	Result	Text message	Action
415	Analog/digital modem	Not applicable	No modem was detected	<ol style="list-style-type: none"> 1. Verify that the modem is properly attached to the server. 2. If the problem remains, replace the modem. <p>If the problem persists, call for service.</p>
			PCI modem detected but not enabled	<ol style="list-style-type: none"> 1. Change the configuration to enable the modem. 2. If the problem remains, replace the modem. <p>If the problem persists, call for service.</p>
		Failed	Modem reset failed	<p>Replace the modem.</p> <p>If the problem persists, call for service.</p>
			No dialtone detected	<ol style="list-style-type: none"> 1. Make sure that the phone line attached to the modem has a dial tone. (Connect a phone to the line and listen, if necessary.) If there is no tone, have the phone line serviced. 2. If the problem remains, replace the modem. <p>If the problem persists, call for service.</p>

Table 14. Diagnostic error messages

Recovering BIOS

If the BIOS has become corrupted, such as from a power failure during a flash update, you can recover the BIOS using the BIOS code page jumper and a BIOS flash diskette.

Note: You can obtain a BIOS flash diskette from one of the following sources:

- Use the ServerGuide program to make a BIOS flash diskette.
- Download a BIOS flash diskette from the World Wide Web. Go to <http://www.pc.ibm.com/support/>, select IBM Server Support, and make the selections for your server.
- Contact your IBM service representative.

To recover the BIOS:

1. Turn off the server and peripheral devices and disconnect all external cables and power cords; then, remove the cover.
2. Locate the BIOS code page jumper (**J19**) on the system board.

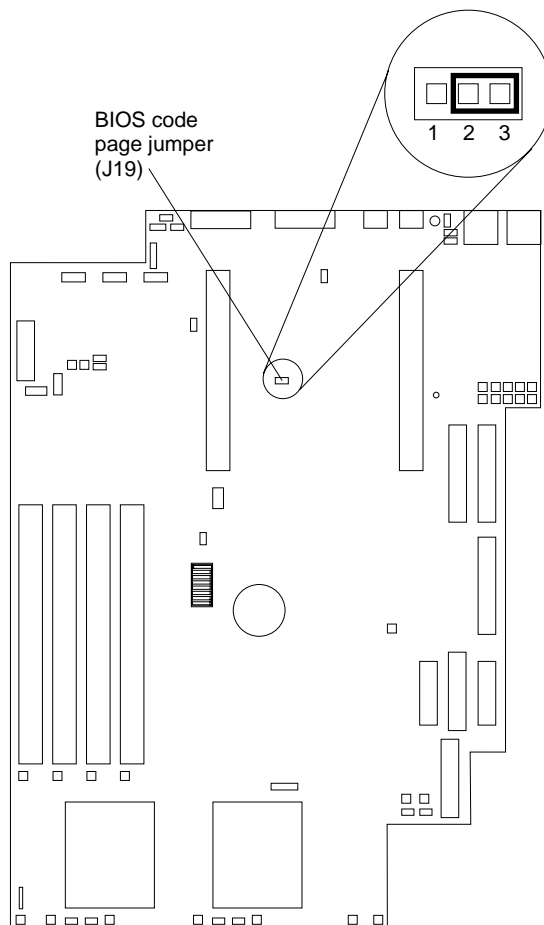

3. Place a jumper on pins 1 and 2 to enable BIOS back page.

Note: Before continuing, refer to “Working inside a server with power on” on page 35.

4. Reconnect all external cables and power cords and turn on the peripheral devices.
5. Insert the BIOS Flash Diskette in the diskette drive.
6. Restart the server. The system begins the power-on self-test (POST) and BIOS flash.

7. Select **1 - Update POST/BIOS** from the menu that contains various flash (update) options.
8. When prompted as to whether you want to save the current code to a diskette, select **N**.
9. When prompted to choose a language, select a language (from 0 to 7) and press **Enter** to accept your choice.
10. Do not reboot your system at this time.
11. Remove the BIOS Flash Diskette from the diskette drive.
12. Turn the server off.
13. Move the jumper on **J19** to pins 2 and 3 to return to normal startup mode.
14. Restart the server. The system should start up normally.
15. Replace the cover.

Identifying problems using status LEDs

If the System Error light in the operator information panel on the front of the server is on, one or more LEDs inside the server may be on. Use the Light Path Diagnostics panel to identify the type of error that occurred.

For LED locations see “System board LEDs” on page 34.

Light Path Diagnostics

You can use the Light Path Diagnostics in your server to quickly identify the type of system error that occurred. The Light Path Diagnostics panel is located on the system board, just behind PCI adapter slot 1. When you press on the Light Path Diagnostics button, the LED on the top-right corner of the panel will illuminate. This shows that the diagnostic circuitry is working correctly.

Your server is designed so that any LEDs that are illuminated can be re-illuminated without AC power after you remove the cover. This feature helps you isolate the problem if an error causes the server to shut down. See “Light Path Diagnostics table” on page 107.

Important: You have up to 12 hours to use the Light Path Diagnostic LED’s after AC power has been removed from the server. After 12 hours, you must power the server up again to be able to use the Light Path Diagnostic LED’s to help locate system errors.

To view the LEDs on the system board:

1. Turn off the server and peripheral devices.
2. Remove all external cables from the server; then, remove the server from the rack and remove the cover. For more information see “Removing the cover” on page 43 for instructions.
3. Press and hold the Light Path Diagnostics (blue) button on the diagnostics panel. The LEDs will illuminate while the switch is pressed.

Note: You can illuminate the LEDs for a maximum of two minutes. After that time, the circuit that powers the LEDs is exhausted.

4. Replace the cover on the server; then, reinstall the server in the rack and connect all external cables. For more information see “Installing the cover” on page 57 for instructions.

Light Path Diagnostics panel

The following illustration shows the LEDs on the diagnostics panel on the system board. See “Light Path Diagnostics table” on page 107 for information on identifying problems using these LEDs.

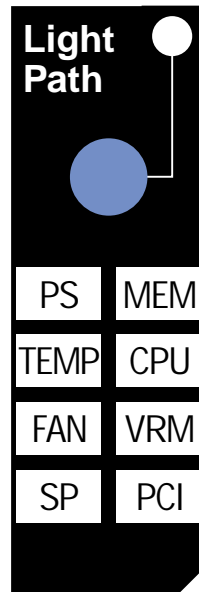

Light Path Diagnostics table

The System Error LED on the operator information panel is lit when certain system errors occur. If the System Error LED on your server is lit, use the following table to help determine the cause of the error and the action you should take.

Lit LED on diagnostics panel	Cause	Action
None	An error has occurred and can not be isolated, or the Advanced System Management Processor has failed.	An error has occurred that is not represented by a Light Path Diagnostics LED. Check the system error log for more information about the error.
PS	Power supply has failed.	Have the system serviced.
TEMP	The system temperature has exceeded a threshold level.	<ol style="list-style-type: none"> 1. Check to see if a fan has failed. If it has, replace the fan. 2. Make sure the room temperature is not too hot. (See “Features and specifications” on page 2.) <p>If the problem persists, have the system serviced.</p>
FAN	A fan has failed or is operating too slowly. Note: A failing fan can also cause the TEMP LED to be on.	Check the LEDs on the fans and replace the indicated fan.
SP	The service processor has failed.	Remove AC power from the server and then restart the server. If the problem persists have the system serviced.
MEM	A memory error occurred.	<ol style="list-style-type: none"> 1. Check the DIMM failure LEDs on the system board. 2. Replace the DIMM indicated by the lit DIMM failure LED.
CPU	One of the microprocessors has failed.	<ol style="list-style-type: none"> 1. Check the microprocessor failure LEDs on the system board. 2. If a microprocessor failure LED is on, make sure the microprocessor is installed correctly (see “Installing the microprocessor” on page 53). 3. If the problem persists, replace the microprocessor. <p>If the problem persists, have the system serviced.</p>
VRM	One of the VRMs on the system board has failed.	Remove AC power from the server and then restart the server. If the problem persists have the system serviced.

Table 15. Light Path Diagnostics

Lit LED on diagnostics panel	Cause	Action
PCI	An error occurred on a PCI bus. The system board caused the error.	<ol style="list-style-type: none"> 1. Check the error log for additional information. 2. If you cannot isolate the failing adapter from the information in the error log, try to determine the failing adapter by removing one adapter at a time from PCI bus B (PCI slots 1 and 2) and restarting the server after each adapter is removed. <p>If the problem persists, have the system serviced.</p>

Table 15. Light Path Diagnostics

Troubleshooting charts

You can use the troubleshooting charts in this section to find solutions to problems that have definite symptoms.

Attention: If diagnostic error messages appear that are not listed in the following tables, make sure that your server has the latest levels of BIOS, ServeRAID, and diagnostics microcode installed.

See “Starting the diagnostic programs” on page 93 to test the server. If you have run the diagnostic test programs or if running the tests does not reveal the problem, call for service.

Look for the symptom in the left column of the chart. Instructions and probable solutions to the problem are in the right column. If you have just added new software or a new option and your server is not working, do the following before using the troubleshooting charts:

- Remove the software or device that you just added.
- Run the diagnostic tests to determine if your server is running correctly.
- Reinstall the new software or new device.

Device	Suggested action
CD-ROM drive	Verify that:
CD-ROM drive is not recognized.	<ol style="list-style-type: none"> 1. The primary IDE channel is enabled in the Configuration/Setup Utility program. 2. All cables and jumpers are installed correctly. 3. The correct device driver is installed for the CD-ROM drive.
Diskette drive	If there is a diskette in the drive, verify that:
Diskette drive in-use light stays on, or the system bypasses the diskette drive.	<ol style="list-style-type: none"> 1. The diskette drive is enabled in the Configuration/Setup Utility program. 2. The diskette is good and not damaged. (Try another diskette if you have one.) 3. The diskette contains the necessary files to start the server. 4. Your software program is OK. <p>If the diskette drive in-use light stays on, or the system continues to bypass the diskette drive, call for service.</p>
Expansion enclosure problems	Verify that:
The SCSI expansion enclosure used to work, but does not work now.	<ol style="list-style-type: none"> 1. The cables for all external SCSI options are connected correctly. 2. The last option in each SCSI chain, or the end of the SCSI cable, is terminated correctly. 3. Any external SCSI option is turned on. You must turn on an external SCSI option before turning on the server. <p>For more information, see your SCSI and expansion enclosure documentation.</p>

Table 16. Troubleshooting charts

Device	Suggested action
General problems	Call for service.
Problems such as broken cover locks or indicator lights not working.	
Intermittent problems	Verify that:
A problem occurs only occasionally and is difficult to detect.	<ol style="list-style-type: none"> 1. All cables and cords are connected securely to the rear of the server and attached options. 2. When the server is turned on, air is flowing from the rear of the server at the fan grill. If there is no air flow, the fan is not working. This causes the server to overheat and shut down. 3. Ensure that the SCSI bus and devices are configured correctly and that the last external device in each SCSI chain is terminated correctly. <p>If the items above are correct, call for service.</p>
Keyboard, mouse, or pointing-device problems.	<ol style="list-style-type: none"> 1. Make sure that the keyboard cable is properly connected to the C2T device breakout cable. 2. Make sure that the C2T device breakout cable is properly connected to the server. 3. Make sure that the server and the monitor are turned on. 4. Try using another keyboard. <p>Note: If you are using the C2T chain, refer to “Testing the C2T chain” on page 73.</p> <p>If the items above are correct, call for service.</p>
All or some keys on the keyboard do not work.	
The mouse or pointing device does not work.	<ol style="list-style-type: none"> 1. Verify that the mouse or pointing-device cable is securely connected and the device drivers are installed correctly. 2. Try using another mouse or pointing device. <p>Note: If you are using the C2T chain, refer to “Testing the C2T chain” on page 73.</p> <p>If the problem remains, call for service.</p>

Table 16. Troubleshooting charts

Device	Suggested action
<p data-bbox="266 212 472 233">Memory problems</p> <p data-bbox="198 258 509 338">The amount of memory displayed is less than the amount of memory installed.</p>	<p data-bbox="558 212 675 233">Verify that:</p> <ol data-bbox="570 310 1419 541" style="list-style-type: none"> <li data-bbox="570 310 1049 331">1. The memory modules are seated properly. <li data-bbox="570 348 1094 369">2. You have installed the correct type of memory. <li data-bbox="570 386 1419 445">3. If you changed the memory, you updated the memory configuration with the Configuration/Setup Utility program. <li data-bbox="570 462 1419 541">4. All banks of memory on the DIMMs are enabled. The server might have automatically disabled a DIMM bank when it detected a problem or a DIMM bank could have been manually disabled. <p data-bbox="558 573 1084 594">Look in the POST error log for error message 289:</p> <ul data-bbox="558 615 1427 884" style="list-style-type: none"> <li data-bbox="558 615 1427 669">• If the DIMM was disabled by a system-management interrupt (SMI), replace the DIMM. <li data-bbox="558 686 1162 842">• If the DIMM was disabled by the user or by POST: <ol data-bbox="631 730 1162 842" style="list-style-type: none"> <li data-bbox="631 730 1162 751">1. Start the Configuration/Setup Utility program. <li data-bbox="631 768 862 789">2. Enable the DIMM. <li data-bbox="631 806 1138 827">3. Save the configuration and restart the server. <li data-bbox="558 858 1157 879">• If you continue to get this error, replace the DIMM. <p data-bbox="558 911 964 932">If the problem persists, call for service.</p>
<p data-bbox="228 957 509 978">Microprocessor problems</p> <p data-bbox="198 1003 521 1058">The server emits a continuous tone during POST.</p>	<p data-bbox="558 957 1175 978">The startup (boot) microprocessor is not working properly.</p> <p data-bbox="558 1010 1427 1064">Verify that the startup microprocessor is seated properly. If it is, replace the startup microprocessor.</p> <p data-bbox="558 1096 967 1117">If the problem remains, call for service.</p>
<p data-bbox="266 1146 472 1167">Monitor problems</p> <p data-bbox="198 1192 412 1213">Testing the monitor.</p>	<p data-bbox="558 1146 1414 1226">Some IBM monitors have their own self-tests. If you suspect a problem with your monitor, refer to the information that comes with the monitor for adjusting and testing instructions.</p> <p data-bbox="558 1257 1094 1278">If you still cannot find the problem, call for service.</p>
<p data-bbox="198 1304 407 1325">The screen is blank.</p>	<p data-bbox="558 1304 675 1325">Verify that:</p> <ol data-bbox="570 1346 1451 1478" style="list-style-type: none"> <li data-bbox="570 1346 1451 1367">1. The server power cord is plugged into the server and a working electrical outlet. <li data-bbox="570 1386 1057 1407">2. The monitor cables are connected properly. <li data-bbox="570 1425 1451 1478">3. The monitor is turned on and the Brightness and Contrast controls are adjusted correctly. <p data-bbox="558 1509 1094 1530">If the servers are C2T chained together, verify that:</p> <ol data-bbox="570 1551 1224 1656" style="list-style-type: none"> <li data-bbox="570 1551 1224 1572">1. The C2T chain cables are securely connected to the servers. <li data-bbox="570 1591 1094 1612">2. The C2T breakout cable is connected properly. <li data-bbox="570 1631 948 1652">3. A powered-up server is selected. <p data-bbox="558 1688 1451 1829">Attention: In some memory configurations, the 3-3-3 beep code might sound during POST followed by a blank display screen. If this occurs and the Boot Fail Count feature in the Start Options of the Configuration/Setup Utility is set to Enabled (its default setting), you must restart the server three times to force the system BIOS to reset the memory connector or bank of connectors from Disabled to Enabled.</p> <p data-bbox="558 1860 1344 1881">If the items above are correct and the screen remains blank, call for service.</p>

Table 16. Troubleshooting charts

Device	Suggested action
Only the cursor appears.	Call for service.
The monitor works when you turn on the server, but goes blank when you start some application programs.	Verify that: <ol style="list-style-type: none"> 1. The primary monitor cable is connected to the C2T device breakout cable. 2. You installed the necessary device drivers for the applications. If the items above are correct and the screen remains blank, call for service.
Wavy, unreadable, rolling, distorted screen, or screen jitter.	If the monitor self-tests show the monitor is OK, consider the location of the monitor. Magnetic fields around other devices (such as transformers, appliances, fluorescent lights, and other monitors) can cause screen jitter or wavy, unreadable, rolling, or distorted screen images. If this happens, turn off the monitor. (Moving a color monitor while it is turned on might cause screen discoloration.) Then move the device and the monitor at least 305 mm (12 in.) apart. Turn on the monitor. <p>Notes:</p> <ol style="list-style-type: none"> 1. To prevent diskette drive read/write errors, be sure the distance between monitors and diskette drives is at least 76 mm (3 in.). 2. Non-IBM monitor cables might cause unpredictable problems. 3. An enhanced monitor cable with additional shielding is available for the 9521 and 9527 monitors. For information about the enhanced monitor cable, see your IBM reseller or IBM marketing representative. If the problem remains, call for service.
Wrong characters appear on the screen.	If the wrong language is displayed, update the BIOS with the correct language. If the problem remains, call for service.
Option problems	Verify that:
An IBM option that was just installed does not work.	<ol style="list-style-type: none"> 1. The option is designed for the server. Refer to the "Support for Netfinity Servers" flowchart for information about obtaining ServerProven™ compatibility information from the World Wide Web. 2. You followed the installation instructions that came with the option. 3. The option is installed correctly. 4. You have not loosened any other installed options or cables. 5. You updated the configuration information in the Configuration/Setup Utility program. Whenever memory or an option is changed, you must update the configuration. If the problem remains, call for service.
An IBM option that used to work does not work now.	Verify that all of the option hardware and cable connections are secure. If the option comes with its own test instructions, use those instructions to test the option. If the failing option is a SCSI option, verify that: <ol style="list-style-type: none"> 1. The cables for all external SCSI options are connected correctly. 2. The last option in each SCSI chain, or the end of the SCSI cable, is terminated correctly. 3. Any external SCSI option is turned on. You must turn on an external SCSI option before turning on the server. If the problem remains, call for service.

Table 16. Troubleshooting charts

Device	Suggested action
<p>Power problems</p> <p>The server does not power on.</p>	<p>Verify that:</p> <ol style="list-style-type: none"> 1. The power cables are properly connected to the server. 2. The electrical outlet functions properly. 3. The type of memory installed is correct. 4. If you just installed an option, remove it, and restart the server. If the server now powers on, you might have installed more options than the power supply supports. <p>If the problem remains, call for service.</p>
<p>Serial port problems</p> <p>The number of serial ports identified by the operating system is less than the number of serial ports installed.</p>	<p>Verify that:</p> <ol style="list-style-type: none"> 1. Each port is assigned a unique address by the Configuration/Setup Utility program and none of the serial ports are disabled. <ul style="list-style-type: none"> Note: The Management connector is the same as a serial port connector, but it is used only by the integrated Advanced System Management Processor, and is not available for use by the operating system. This port does not appear in the Configuration/Setup Utility program menus; it can be configured using Netfinity Manager. 2. The serial-port adapter, if you installed one, is seated properly. <p>If the problem still exists, call for service.</p>
<p>A serial device does not work. For more information about the serial port see "Serial port" on page 59.</p>	<p>Verify that:</p> <ol style="list-style-type: none"> 1. The device is compatible with the server. 2. The serial port is enabled and is assigned a unique address. 3. Make sure that the device is not connected to the management port C. <ul style="list-style-type: none"> Note: The management C connector is the same as a serial port connector, but it is used only by the integrated Advanced System Management Processor and is not available for use by the operating system. This port does not appear in the Configuration/Setup Utility program menus; it can be configured using Netfinity Manager. <p>If the problem still exists, call for service.</p>
<p>Software problem</p> <p>Suspected software problem.</p>	<p>To determine if problems are caused by the software, verify that:</p> <ol style="list-style-type: none"> 1. Your server has the minimum memory requirements needed to use the software. For memory requirements, refer to the information that comes with the software. <ul style="list-style-type: none"> Note: If you have just installed an adapter or memory, you might have a memory address conflict. 2. The software is designed to operate on your server. 3. Other software works on your server. 4. The software that you are using works on another system. <p>If you received any error messages when using the software program, refer to the information that comes with the software for a description of the messages and solutions to the problem.</p> <p>If the items above are correct and the problem remains, contact your place of purchase.</p>

Table 16. Troubleshooting charts

Device	Suggested action
<p data-bbox="191 212 483 268">Universal Serial Bus (USB) port problems</p> <p data-bbox="167 285 475 312">A USB device does not work.</p>	<p data-bbox="524 212 646 239">Verify that:</p> <ol data-bbox="537 254 1417 464" style="list-style-type: none"> <li data-bbox="537 254 1417 310">1. You are not trying to use a USB device during POST if you have a standard (non-USB) keyboard attached to the keyboard port. <li data-bbox="537 394 1013 422">2. The correct USB device driver is installed. <li data-bbox="537 436 1052 464">3. Your operating system supports USB devices. <p data-bbox="524 489 954 516">If the problem still exists, call for service.</p>

Table 16. Troubleshooting charts

Troubleshooting an Ethernet controller

This section provides troubleshooting information for problems that might occur with an 10/100 Mbps Ethernet controller.

Network connection problems

If an Ethernet controller cannot connect to the network, check the following:

- Make sure that the cable is installed correctly.

The network cable must be securely attached at all connections. If the cable is attached but the problem persists, try a different cable.

If you set the Ethernet controller to operate at 100 Mbps, you must use Category 5 cabling.

If you directly connect two workstations (without a hub), or if you are not using a hub with X ports, use a crossover cable.

Note: To determine whether a hub has an X port, check the port label. If the label contains an X, the hub has an X port.

- Determine if the hub supports auto-negotiation. If not, try configuring the integrated Ethernet controller manually to match the speed and duplex mode of the hub.
- Make sure that you are using the correct device drivers, supplied with your server.
- Check for operating system-specific causes for the problem.
- Make sure that the device drivers on the client and server are using the same protocol.
- Test the Ethernet controller.

How you test the Ethernet controller depends on which operating system you are using (see the Ethernet controller device driver README file).

Ethernet controller troubleshooting chart

You can use the following troubleshooting chart to find solutions to 10/100 Mbps Ethernet controller problems that have definite symptoms.

Ethernet controller problem	Suggested Action
The server stops running when loading device drivers.	<p>The PCI BIOS interrupt settings are incorrect.</p> <p>Check the following:</p> <ul style="list-style-type: none"> • Determine if the interrupt (IRQ) setting assigned to the Ethernet controller is also assigned to another device in the Configuration/Setup Utility program. <p>Although interrupt sharing is allowed for PCI devices, some devices do not function well when they share an interrupt with a dissimilar PCI device. Try changing the IRQ assigned to the Ethernet controller or the other device. For example, for NetWare Versions 3 and 4 it is recommended that disk controllers not share interrupts with LAN controllers.</p> <ul style="list-style-type: none"> • Make sure that you are using the most recent device driver available from the World Wide Web. • Run the network diagnostic program. <p>If the problem remains, call for service.</p>
Data is incorrect or sporadic.	<p>Check the following:</p> <ul style="list-style-type: none"> • Make sure that you are using Category 5 cabling when operating the server at 100 Mbps. • Make sure that the cables do not run close to noise-inducing sources like fluorescent lights.
The Ethernet controller stopped working when another adapter was added to the server.	<p>Check the following:</p> <ul style="list-style-type: none"> • Make sure that the cable is connected to the Ethernet controller. • Make sure that your PCI system BIOS is current. • Reseat the adapter. • Determine if the interrupt (IRQ) setting assigned to the Ethernet adapter is also assigned to another device in the Configuration/Setup Utility program. <p>Although interrupt sharing is allowed for PCI devices, some devices do not function well when they share an interrupt with a dissimilar PCI device. Try changing the IRQ assigned to the Ethernet adapter or the other device.</p> <p>If the problem remains, call for service.</p>
The Ethernet controller stopped working without apparent cause.	<p>Check the following:</p> <ul style="list-style-type: none"> • Run diagnostics for the Ethernet controller. • Try a different connector on the hub. • Reinstall the device drivers. Refer to your operating-system documentation and to the ServerGuide information. <p>If the problem remains, call for service.</p>

Table 17. Ethernet troubleshooting chart

Ethernet controller messages

The integrated Ethernet controllers might display messages from the following device drivers:

- Novell™ NetWare™ or IntraNetWare Server ODI
- NDIS Adapter for level 4.0 (Windows NT)

Novell NetWare or IntraNetWare server ODI driver teaming messages

This section provides explanations of the error messages for the Novell NetWare or IntraNetWare server ODI driver, and suggested actions to resolve each problem.

Message	Description
Couldn't allocate resources	Explanation: An unknown error has occurred when trying to allocate needed resources for the AFT Module. Action: <ul style="list-style-type: none"> • Check the server configuration. If the problem persists, contact your network supplier. • Verify that the Ethernet controller is enabled. If the Ethernet controller is enabled, run the diagnostic programs.
AFT group for primary adapter in slot <i>nnn</i> already exists.	Explanation: An attempt was made to rebind an adapter already in an AFT group. Action: Check the AFT slot numbers for existing AFT teams. If the problem persists, contact your network supplier.
Error locating DCT addresses in internal table. Make sure that you have loaded LAN drivers after loading AFT.NLM.	Explanation: The bind command was entered prior to loading the device driver. The device driver must be loaded after loading AFT.NLM but before any bind command can be issued. Action: Load the driver for the supported adapter and try loading the AFT module again. If the problem persists, contact your network supplier.
Insufficient number of arguments specified.	Explanation: The appropriate or expected number of parameters was not entered in a command. Action: Check the parameters required for the given command. If the problem persists, contact your network supplier.
Duplicate slot numbers detected.	Explanation: An attempt has been made to bind the same slot number more than once. Action: Check the slot numbers entered during the bind. Adapter slot numbers must be valid and unique. If the problem persists, contact your network supplier.
'Xxx' is not supported for AFT team.	Explanation: A bind command has been issued for adapters not supported by AFT.NLM. Action: Make sure that you attempt to bind only adapters supported by AFT.NLM.
Primary and Secondary adapters do not match. AFT group is not created.	Explanation: A bind command was entered for an adapter team that is a combination of server and client adapters. An AFT team must be a grouping of the same classification of adapter. Action: Verify that all the adapters bound in a team are of the same classification.
Requested number of Secondary cards are not found.	Explanation: The number of adapters specified in the bind command could not be located. Action: Verify the numbers and slot locations of the adapters to be bound. If the problem persists, contact your network supplier.
Failed to create AFT group. Make sure that the drivers for supported adapters are loaded, primary adapter is bound to protocols, and secondary adapter is not bound to any protocols.	Explanation: Binding of protocol failed. Protocol is either not bound to any adapter or is bound to more than one adapter in the group. Action: Ensure that the protocol is bound to only adapter in an AFT team.

Table 18. NetWare driver messages for the Ethernet controller

Error identifying slot numbers for the specified board names.	Explanation: The mapping between the board name entered and the slot number for an adapter could not be established. Action: Check the board name for the adapter before issuing the bind command. If the problem persists, contact your network supplier.
Can't unbind specified slot from AFT group. Make sure that the slot you specified is for the primary adapter in an AFT group.	Explanation: The number entered in the unbind command was not the primary adapter in an AFT group. Action: Reissue the unbind command and specify the slot number for the primary adapter.
LAN adapter at slot <i>nnnn</i> (Port 0xaa) failed to reset. Check the state of the adapter.	Explanation: The adapter that you specified could not be initialized. Action: <ol style="list-style-type: none"> 1. Load the driver for the supported adapter. 2. Check that the adapter is seated properly in the slot and try loading the AFT module again. <p>If the problem persists, contact your network supplier.</p>
AFT is not supported on this version of NetWare(TM).	Explanation: The NetWare on your server is not a version supported by AFT. Action: Load and bind AFT only on supported versions of NetWare (currently version 4.11 and above).
Failed to allocate resources tags.	Explanation: An unknown error has occurred when trying to allocate needed resources for the AFT module. Action: Check Server Configuration. If the problem persists, contact your network supplier.
Please unload all LAN drivers before unloading AFT.NLM.	Explanation: An attempt was made to unload the AFT.NLM module before unloading the adapter driver. Action: Unload the adapter driver before unloading the AFT module.

Table 18. NetWare driver messages for the Ethernet controller

NDIS 4.0 (Windows NT) driver messages

This section contains the error messages for the NDIS 4.0 drivers. The explanation and recommended action are included with each message.

Error code (hex)	Description
0x00	Explanation: The driver could not register the specified interrupt. Action: Using the Configuration/Setup utility, make sure that a PCI interrupt is assigned to your Ethernet card, and that Ethernet is enabled.
0x01	Explanation: One of the PCI cards did not get the required resources. Action: Using the Configuration/Setup utility, make sure that a PCI interrupt is assigned to your Ethernet card, and that Ethernet is enabled.
0x02	Explanation: Bad node address (multicast address). Action: Make sure the locally administered address is valid, if one is specified. The address can not be a multicast address.
0x03	Explanation: Failed self-test. Action: Make sure a cable is attached to the Ethernet connector. If the problem persists, call for service.
0x0D	Explanation: Could not allocate enough memory for transmit queues. Action: <ol style="list-style-type: none"> 1. From the Windows NT desktop, select Start -> Control Panel -> Networks -> Adapters. 2. Select your IBM Ethernet adapter from the list. 3. Select Properties -> Advanced. 4. Lower the resource values that apply to the transmit queue.
0x0E	Explanation: Could not allocate enough memory for receive queue. Action: <ol style="list-style-type: none"> 1. From the Windows NT desktop, select Start -> Control Panel -> Networks -> Adapters. 2. Select your IBM Ethernet adapter from the list. 3. Select Properties -> Advanced. 4. Lower the resource values that apply to the receive queue.
0x0F	Explanation: Could not allocate enough memory for other structures. Action: <ol style="list-style-type: none"> 1. From the Windows NT desktop, select Start -> Control Panel -> Networks -> Adapters. 2. Select your IBM Ethernet adapter from the list. 3. Select Properties -> Advanced. 4. Lower the value for the resource named in the message.
0x10	Explanation: Did not find any Ethernet controllers. Action: Using the Configuration/Setup utility, make sure that Ethernet is enabled.
0x11	Explanation: Multiple Ethernet controllers found, but none matched the required ID. Action: Using the Configuration/Setup utility, make sure that Ethernet is enabled.
0x13	Explanation: Did not find any Ethernet controllers that matched the required subven/subdev. Action: Using the Configuration/Setup utility, make sure that Ethernet is enabled.
0x16	Explanation: Single adapter found but multiple instances tried to load. Action: Using the Configuration/Setup utility, make sure that Ethernet is enabled, and that the slot containing the IBM Netfinity 10/100 Ethernet Adapter or the IBM 10/100 Etherjet PCI adapter is enabled.
0x17	Explanation: Slot parameter not specified in the registry. Action: Remove the adapter driver and reinstall it. If the problem persists, call for service.

Table 19. NDIS (Windows NT or Windows 2000) driver messages for the Ethernet controller

Error code (hex)	Description
All other 4-character hexadecimal codes	Action: Call for service.

Table 19. NDIS (Windows NT or Windows 2000) driver messages for the Ethernet controller

Ethernet teaming messages:

Event ID	Type	Description
01	Error	Explanation: Team Name and physical adapter name are the same. This is an invalid configuration. Action: Reconfigure the adapter team by double-clicking the PROSet icon in the control panel.
02	Error	Explanation: Unable to allocate required resources. Action: Free some memory resources and restart.
03	Error	Explanation: Unable to read required registry parameters. Action: Reconfigure the adapter team by double-clicking the PROSet icon in the control panel.
04	Error	Explanation: Unable to bind to physical adapter. Action: Reconfigure the adapter team by double-clicking the PROSet icon in the control panel.
05	Error	Explanation: Unable to initialize an adapter team. Action: Reconfigure the adapter team by double-clicking the PROSet icon in the control panel.
06	Informational	Explanation: Team <i>nn</i> . Primary adapter is initialized. Action: None.
07	Informational	Explanation: Team <i>nn</i> . Secondary adapter is initialized. Action: None.
08	Informational	Explanation: Team <i>nn</i> . Virtual adapter or Team is initialized. Action: None.
09	Informational	Explanation: Team <i>nn</i> . Primary adapter is switching over. Action: None.
10	Warning	Explanation: Team <i>nn</i> . Adapter link down. Action: Make sure the adapter is functioning properly.
11	Informational	Explanation: Team <i>nn</i> . Secondary adapter took over. Action: None.
12	Warning	Explanation: Team <i>nn</i> . Secondary adapter is deactivated from the Team. Action: Make sure the secondary adapter is functioning properly and that the adapter cable is securely connected to the LAN.
13	Informational	Explanation: Team <i>nn</i> . Secondary adapter has rejoined the Team. Action: None.
14	Informational	Explanation: Team <i>nn</i> . Secondary adapter link is up. Action: None.
15	Error	Explanation: Team <i>nn</i> . The last adapter has lost its link. Network connection has been lost. Action: Shut down the server and replace the adapters; then, restart the server to reestablish the connection.
16	Informational	Explanation: Team <i>nn</i> . An adapter has re-established the link. Network connection has been restored. Action: None.
17	Informational	Explanation: Team <i>nn</i> . Preferred primary adapter has been detected. Action: None.
18	Informational	Explanation: Team <i>nn</i> . Preferred secondary adapter has been detected. Action: None.
19	Informational	Explanation: Team <i>nn</i> . Preferred primary adapter took over. Action: None.
20	Informational	Explanation: Team <i>nn</i> . Preferred secondary adapter took over. Action: None.
21	Warning	Explanation: Team <i>nn</i> . Primary adapter does not sense any Probes. Possible reason: partitioned Team. Action: Make sure the cables of the adapter team are connected to the same LAN segment. Reconfigure the team if necessary.

Table 20. NDIS (Windows NT or Windows 2000) driver teaming messages for the Ethernet controller

Replacing the battery

When replacing the battery you must replace it with a lithium battery of the same type, from the same manufacturer. To avoid possible danger read and follow the safety statement below.

To order replacement batteries, call 1-800-772-2227 within the United States, and 1-800-465-7999 or 1-800-465-6666 within Canada. Outside the U.S. and Canada, call your IBM reseller or IBM marketing representative.

Note: After you replace the battery, you must reconfigure your server and reset the system date and time.

Statement 2

CAUTION:



When replacing the lithium battery, use only IBM Part Number 33F8354 or an equivalent type battery recommended by the manufacturer. If your system has a module containing a lithium battery, replace it only with the same module type made by the same manufacturer. The battery contains lithium and can explode if not properly used, handled, or disposed of.

Do not:

- **Throw or immerse into water.**
- **Heat to more than 100 C (212 F)**
- **Repair or disassemble**

Dispose of the battery as required by local ordinances or regulations.

Complete the following steps to replace the battery:

1. Read “Safety information” on page 37, and follow any special handling and installation instructions supplied with the replacement battery.
2. Turn off the server and peripheral devices and disconnect all external cables and power cords; then, remove the server cover.
3. Remove the battery:
 - a. Use one finger to lift the battery clip over the battery.
 - b. Use one finger to slightly slide the battery out from its socket. The spring mechanism will push the battery out toward you as you slide it from the socket.
 - c. Use your thumb and index finger to pull the battery from under the battery clip.
 - d. Ensure that the battery clip is touching the base of the battery socket by pressing gently on the clip.

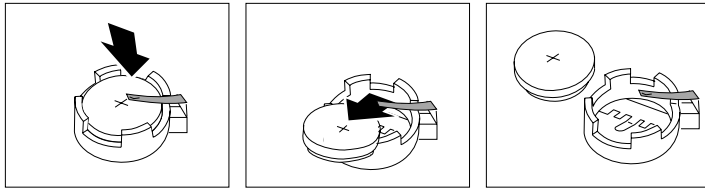

4. Insert the new battery:

- a. Tilt the battery so that you can insert it into the socket, under the battery clip.
- b. As you slide it under the battery clip, press the battery down into the socket.

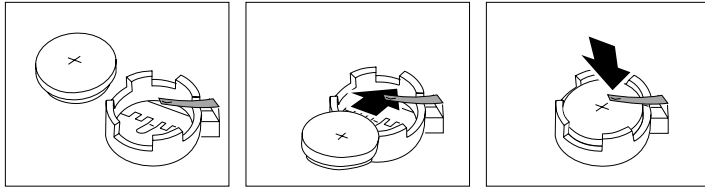

5. Reinstall the server cover and connect the cables.

6. Turn on the server.

7. Start the Configuration/Setup Utility program and set configuration parameters.

- Set the system date and time.
- Set the power-on password.
- Reconfigure your server.

Getting help, service, and information

If you need help, service, technical assistance, or just want more information about IBM products, you will find a wide variety of sources available from IBM to assist you.

For example, IBM maintains pages on the World Wide Web where you can get information about IBM products and services, find the latest technical information, and download device drivers and updates. Some of these pages are:

Table 21. Getting help, service, and information World Wide Web addresses

http://www.ibm.com	Main IBM home page
http://www.ibm.com/pc	IBM Personal Computing
http://www.ibm.com/pc/support	IBM Personal Computing Support
http://www.ibm.com/pc/us/ibmpc	IBM Commercial Desktop PCs (U.S.)
http://www.ibm.com/pc/us/intellistation	IBM IntelliStation Workstations (U.S.)
http://www.ibm.com/pc/us/accessories	Options by IBM (U.S.)
http://www.ibm.com/eserver/xseries	IBM xSeries servers (U.S.)
http://www.ibm.com/pc/us/server/sguide	IBM ServerGuide (U.S.)
http://www.ibm.com/pc/us/netfinity/system_management	IBM Systems Management (U.S.)
http://www.ibm.com/software/os/warp-server	IBM OS/2 Warp Server
http://www.ibm.com/pc/techconnect	IBM TechConnect

You can select a country-specific Web site from these pages.

You might also want to visit the Web pages of other companies for information about other operating systems, software, and accessories. The following are some other Web sites you might find helpful:

<http://www.lotus.com>

<http://www.tivoli.com>

<http://www.microsoft.com>

<http://www.novell.com>

<http://www.sco.com>

<http://www.adaptec.com>

<http://www.apcc.com>

<http://www.norton.com>

Help is also available from bulletin boards and online services, as well as by fax and telephone. This section provides information about these sources.

Services available and telephone numbers listed are subject to change without notice.

Service support

With the original purchase of an IBM hardware product, you have access to extensive support coverage. During the IBM hardware product warranty period, you may call the IBM HelpCenter (1-800-772-2227 in the U.S.) for hardware product assistance covered under the terms of the IBM hardware warranty. See “Getting help by telephone” on page 128 for HelpCenter telephone numbers in other countries.

The following services are available during the warranty period:

- Problem determination - Trained personnel are available to assist you with determining if you have a hardware problem and deciding what action is necessary to fix the problem.
- IBM hardware repair - If the problem is determined to be caused by IBM hardware under warranty, trained service personnel are available to provide the applicable level of service.
- Engineering change management - Occasionally, there might be changes that are required after a product has been sold. IBM or your reseller, if authorized by IBM, will make Engineering Changes (ECs) available that apply to your hardware.

Be sure to retain your proof of purchase to obtain warranty service.

Please have the following information ready when you call:

- Machine Type and Model
- Serial numbers of your IBM hardware products
- Description of the problem
- Exact wording of any error messages
- Hardware and software configuration information

If possible, be at your server when you call.

The following items are not covered:

- Replacement or use of non-IBM parts or nonwarranted IBM parts
Note: All warranted parts contain a 7-character identification in the format IBM FRU XXXXXXX.
- Identification of software problem sources
- Configuration of BIOS as part of an installation or upgrade
- Changes, modifications, or upgrades to device drivers
- Installation and maintenance of network operating systems (NOS)
- Installation and maintenance of application programs

Refer to your IBM hardware warranty for a full explanation of IBM's warranty terms.

Before you call for service

Many computer problems can be solved without outside assistance, by using the online help or by looking in the online or printed documentation that comes with your computer or software. Also, be sure to read the information in any README files that come with your software.

Most computers, operating systems, and application programs come with documentation that contains troubleshooting procedures and explanations of error messages. The documentation that comes with your computer also contains information about the diagnostic tests you can perform.

If you receive a POST error code when you turn on your computer, refer to the POST error-message charts in your hardware documentation. If you do not receive a POST error code, but suspect a hardware problem, refer to the troubleshooting information in your hardware documentation or run the diagnostic tests.

If you suspect a software problem, consult the documentation (including README files) for the operating system or application program.

Getting customer support and service

Purchasing an IBM PC hardware product entitles you to standard help and support during the warranty period. If you need additional support and services, a wide variety of extended services are available for purchase that address almost any need.

Using the World Wide Web

On the World Wide Web, the IBM Personal Computing Web site has up-to-date information about IBM Personal Computer products and support. The address for the IBM Personal Computing home page is:

<http://www.ibm.com/pc>

You can find support information for your IBM products, including supported options, on the IBM Personal Computing Support page at:

<http://www.ibm.com/pc/support>

If you select Profile from the support page, you can create a customized support page that is specific to your hardware, complete with Frequently Asked Questions, Parts Information, Technical Hints and Tips, and Downloadable Files. You will have the information you need, all in one place. In addition, you can choose to receive e-mail notifications whenever new information becomes available about your registered products. You also can access online support forums, which are community sites monitored by IBM support staff.

For information about specific Personal Computer products, visit the following pages:

<http://www.ibm.com/pc/us/intellistation>

<http://www.ibm.com/pc/us/ibmpc>

<http://www.ibm.com/eserver/xseries>

<http://www.ibm.com/pc/us/thinkpad>

<http://www.ibm.com/pc/us/accessories>

http://www.direct.ibm.com/content/home/en_US/aptiva

You can select a country-specific Web site from these pages.

Using electronic support services

If you have a modem, you can get help from several popular services. Online information services provide assistance through question-and-answer message areas, live chat rooms, searchable databases, and more.

Technical information is available on a wide range of topics, such as:

- Hardware setup and configuration
- Preinstalled software
- Windows, OS/2, and DOS
- Networking
- Communications
- Multimedia

In addition, the latest device driver updates are available.

Commercial online services, such as America Online (AOL), contain information about IBM products. (For AOL, use the keyword **IBM**.)

Getting information by fax

If you have a touch-tone telephone and access to a fax machine, in the U.S. and Canada you can receive by fax marketing and technical information on many topics, including hardware, operating systems, and local area networks (LANs). You can call the IBM Automated Fax System 24 hours a day, 7 days a week. Follow the recorded instructions, and the requested information will be sent to your fax machine.

In the U.S. and Canada, to access the IBM Automated Fax System, call 1-800-426-3395.

Getting help online

Online Housecall is a remote communication tool that allows an IBM technical-support representative to access your PC by modem. Many problems can be remotely diagnosed and corrected quickly and easily. In addition to a modem, a remote-access application program is required. This service is not available for servers. There might be a charge for this service, depending on the request.

For more information about configuring your PC for Online Housecall:

- In the U.S., call 1-800-772-2227.
- In Canada, call 1-800-565-3344.
- In all other countries, contact your IBM reseller or IBM marketing representative.

Getting help by telephone

During the warranty period, you can get help and information by telephone through the IBM HelpCenter. Expert technical-support representatives are available to assist you with questions you might have on the following:

- Setting up your computer and IBM monitor
- Installing and setting up IBM options purchased from IBM or an IBM reseller
- 30-day, preinstalled-operating-system support
- Arranging for service (on-site or carry-in)
- Arranging for overnight shipment of customer-replaceable parts

In addition, if you purchased an IBM PC Server or IBM Netfinity Server, you are eligible for IBM Start Up Support for 90 days after installation. This service provides assistance for:

- Setting up your network operating system
- Installing and configuring interface cards
- Installing and configuring network adapters

Please have the following information ready when you call:

- Machine Type and Model
- Serial numbers of your computer, monitor, and other components, or your proof of purchase
- Description of the problem
- Exact wording of any error messages
- Hardware and software configuration information for your system

If possible, be at your computer when you call.

In the U.S. and Canada, these services are available 24 hours a day, 7 days a week. In the U.K., these services are available Monday through Friday, from 9:00 a.m. to 6:00 p.m.¹

¹.Response time will vary depending on the number and complexity of incoming calls.

Table 22. International help phone numbers

Country		Telephone number
Austria	Österreich	01-24 692 5901
Belgium - Dutch	Belgie	02-210 9820
Belgium - French	Belgique	02-210 9800
Canada	Toronto only	416-383-3344
Canada	Canada - all other	1-800-565-3344
Denmark	Danmark	35 25 02 91
Finland	Suomi	09-22 931 840
France	France	01-69 32 40 40
Germany	Deutschland	069-6654 9040
Ireland	Ireland	01-815 9202
Italy	Italia	02-482 9202
Luxembourg	Luxembourg	298-977 5063
Netherlands	Nederland	020-504 0501
Norway	Norge	23 05 32 40
Portugal	Portugal	21-791 51 47
Spain	España	91-662 49 16
Sweden	Sverige	08-751 52 27
Switzerland - German	Schweiz	0848-80 52 52
Switzerland - French	Suisse	0848-80 52 52
Switzerland - Italian	Svizzera	0848-80 52 52
United Kingdom	United Kingdom	01475-555 055
U.S.A. and Puerto Rico	U.S.A. and Puerto Rico	1-800-772-2227
Austria	Österreich	01-24 692 5901

In all other countries, contact your IBM reseller or IBM marketing representative.

Getting help around the world

If you travel with your computer or need to move it to another country, you can register for International Warranty Service. When you register with the International Warranty Service Office, you will receive an International Warranty Service Certificate that is honored virtually worldwide, wherever IBM or IBM resellers sell and service IBM PC products.

For more information or to register for International Warranty Service:

- In the U.S. or Canada, call 1-800-497-7426.
- In Europe, call 44-1475-893638 (Greenock, U.K.).
- In Australia and New Zealand, call 61-2-9354-4171.

In all other countries, contact your IBM reseller or IBM marketing representative.

Purchasing additional services

During and after the warranty period, you can purchase additional services, such as support for IBM and non-IBM hardware, operating systems, and application programs; network setup and configuration; upgraded or extended hardware repair services; and custom installations. Service availability and name might vary by country.

Enhanced PC support line

Enhanced PC Support is available for desktop and mobile IBM computers that are not connected to a network. Technical support is provided for IBM computers and IBM or non-IBM options, operating systems, and application programs on the Supported Products list.

This service includes technical support for:

- Installing and configuring your out-of-warranty IBM computer
- Installing and configuring non-IBM options in IBM computers
- Using IBM operating systems in IBM and non-IBM computers
- Using application programs and games
- Tuning performance
- Installing device drivers remotely
- Setting up and using multimedia devices
- Identifying system problems
- Interpreting documentation

You can purchase this service on a per-call basis, as a multiple-incident package, or as an annual contract with a 10-incident limit. For more information about purchasing Enhanced PC Support, see “Ordering support line services” on page 131.

900-number operating system and hardware support line

In the U.S., if you prefer to obtain technical support on a pay-as-you-go basis, you can use the 900-number support line. The 900-number support line provides support for IBM PC products that are out of the warranty period.

To access this support, call 1-900-555-CLUB (2582). You will be notified of the charge per minute.

Network and server support line

Network and Server Support is available for simple or complex networks made up of IBM servers and workstations using major network operating systems. In addition, many popular non-IBM adapters and network interface cards are supported.

This service includes all of the features of the Enhanced PC Support Line, plus:

- Installing and configuring client workstations and servers
- Identifying system problems and correcting problems on the client or the server
- Using IBM and non-IBM network operating systems
- Interpreting documentation

You can purchase this service on a per-call basis, as a multiple-incident package, or as an annual contract with a 10-incident limit. For more information about purchasing Network and Server Support, see “ Ordering support line services” .

Ordering support line services

Enhanced PC Support Line and Network and Server Support Line services are available for products on the Supported Products list. To receive a Supported Products list:

- In the U.S.:
 1. Call 1-800-426-3395.
 2. Select document number 11683 for Network and Server support.
 3. Select document number 11682 for Enhanced PC support.
- In Canada, contact IBM Direct at 1-800-465-7999, or:
 1. Call 1-800-465-3299.
 2. Select the HelpWare catalog.
- In all other countries, contact your IBM reseller or IBM marketing representative.

For more information or to purchase these services:

- In the U.S., call 1-800-772-2227.
- In Canada, call 1-800-465-7999.
- In all other countries, contact your HelpCenter.

Warranty and repair services

You can upgrade your standard hardware warranty service or extend the service beyond the warranty period.

Warranty upgrades in the U.S. include:

- Carry-in service to on-site service
If your warranty provides carry-in repair service, you can upgrade to on-site repair service, either standard or premium. The standard upgrade provides a trained servicer within the next business day (9 a.m. to 5 p.m., local time, Monday through Friday). The premium upgrade provides 4-hour average response, 24 hours a day, 7 days a week.
- On-site service to premium on-site service
If your warranty provides for on-site service, you can upgrade to premium on-site service (4-hour average on-site response, 24 hours a day, 7 days a week).

You also can extend your warranty. Warranty and Repair Services offers a variety of post-warranty maintenance options, including ThinkPad EasyServ Maintenance Agreements. Availability of the services varies by product.

For more information about warranty upgrades and extensions:

- In the U.S., call 1-800-426-4968.
- In Canada, call 1-800-465-7999.
- In all other countries, contact your IBM reseller or IBM marketing representative.

Ordering publications

Additional publications are available for purchase from IBM. For a list of publications available in your country:

- In the U.S., Canada, and Puerto Rico, call 1-800-879-2755.
- In other countries, contact your IBM reseller or IBM marketing representative.

Appendix A. Product warranties and notices

This chapter contains warranty and emission notices. It also contains trademarks and general-information notices.

Warranty Statements

The warranty statements consist of two parts: Part 1 and Part 2. Part 1 varies by country. Part 2 is the same for all countries. Be sure to read both the Part 1 that applies to your country and Part 2.

- **United States, Puerto Rico, and Canada (Z125-4753-05 11/97)**
(“ IBM Statement of Limited Warranty for United States, Puerto Rico, and Canada (Part 1 - General Terms)”)
- **Worldwide except Canada, Puerto Rico, Turkey, and United States (Z125-5697-01 11/97)**
(“ IBM Statement of Warranty Worldwide except Canada, Puerto Rico, Turkey, United States (Part 1 - General Terms)” on page 136)
- **Worldwide Country-Unique Terms**
(“ Part 2 - Worldwide Country-Unique Terms” on page 138)

IBM Statement of Limited Warranty for United States, Puerto Rico, and Canada (Part 1 - General Terms)

This Statement of Limited Warranty includes Part 1 - General Terms and Part 2 - Country-unique Terms. *The terms of Part 2 may replace or modify those of Part 1.* The warranties provided by IBM in this Statement of Limited Warranty apply only to Machines you purchase for your use, and not for resale, from IBM or your reseller. The term "Machine" means an IBM machine, its features, conversions, upgrades, elements, or accessories, or any combination of them. The term "Machine" does not include any software programs, whether pre-loaded with the Machine, installed subsequently or otherwise. Unless IBM specifies otherwise, the following warranties apply only in the country where you acquire the Machine. Nothing in this Statement of Warranty affects any statutory rights of consumers that cannot be waived or limited by contract. If you have any questions, contact IBM or your reseller.

Machine - IBM @server xSeries 330

Warranty Period* - Three Years

*Contact your place of purchase for warranty service information. Some IBM Machines are eligible for On-site warranty service depending on the country where service is performed.

The IBM Warranty for Machines

IBM warrants that each Machine 1) is free from defects in materials and workmanship and 2) conforms to IBM's Official Published Specifications. The warranty period for a Machine is a specified, fixed period commencing on its Date of Installation. The date on your sales receipt is the Date of Installation, unless IBM or your reseller informs you otherwise.

During the warranty period IBM or your reseller, if approved by IBM to provide warranty service, will provide repair and exchange service for the Machine, without charge, under the type of service designated for the Machine and will manage and install engineering changes that apply to the Machine.

If a Machine does not function as warranted during the warranty period, and IBM or your reseller are unable to either 1) make it do so or 2) replace it with one that is at least functionally equivalent, you may return it to your place of purchase and your money will be refunded. The replacement may not be new, but will be in good working order.

Extent of Warranty

The warranty does not cover the repair or exchange of a Machine resulting from misuse, accident, modification, unsuitable physical or operating environment, improper maintenance by you, or failure caused by a product for which IBM is not responsible. The warranty is voided by removal or alteration of Machine or parts identification labels.

THESE WARRANTIES ARE YOUR EXCLUSIVE WARRANTIES AND REPLACE ALL OTHER WARRANTIES OR CONDITIONS, EXPRESS OR IMPLIED, INCLUDING, BUT NOT LIMITED TO, THE IMPLIED WARRANTIES OR CONDITIONS OF MERCHANTABILITY AND FITNESS FOR A PARTICULAR PURPOSE. THESE WARRANTIES GIVE YOU SPECIFIC LEGAL RIGHTS AND YOU MAY ALSO HAVE OTHER RIGHTS WHICH VARY FROM JURISDICTION TO JURISDICTION. SOME JURISDICTIONS DO NOT ALLOW THE EXCLUSION OR LIMITATION OF EXPRESS OR IMPLIED WARRANTIES, SO THE ABOVE EXCLUSION OR LIMITATION MAY NOT APPLY TO YOU. IN THAT EVENT, SUCH WARRANTIES ARE LIMITED IN DURATION TO THE WARRANTY PERIOD. NO WARRANTIES APPLY AFTER THAT PERIOD.

Items Not Covered by Warranty

IBM does not warrant uninterrupted or error-free operation of a Machine.

Unless specified otherwise, IBM provides non-IBM machines **WITHOUT WARRANTIES OF ANY KIND.**

Any technical or other support provided for a Machine under warranty, such as assistance via telephone with "how-to" questions and those regarding Machine set-up and installation, will be provided **WITHOUT WARRANTIES OF ANY KIND.**

Warranty Service

To obtain warranty service for the Machine, contact your reseller or IBM. In the United States, call IBM at 1-800-772-2227. In Canada, call IBM at 1-800-565-3344. You may be required to present proof of purchase.

IBM or your reseller provides certain types of repair and exchange service, either at your location or at a service center, to keep Machines in, or restore them to, conformance with their Specifications. IBM or your reseller will inform you of the available types of service for a Machine based on its country of installation. IBM may repair the failing Machine or exchange it at its discretion.

When warranty service involves the exchange of a Machine or part, the item IBM or your reseller replaces becomes its property and the replacement becomes yours. You represent that all removed items are genuine and unaltered. The replacement may not be new, but will be in good working order and at least functionally equivalent to the item replaced. The replacement assumes the warranty service status of the replaced item.

Any feature, conversion, or upgrade IBM or your reseller services must be installed on a Machine which is 1) for certain Machines, the designated, serial-numbered Machine and 2) at an engineering-change level compatible with the feature, conversion, or

upgrade. Many features, conversions, or upgrades involve the removal of parts and their return to IBM. A part that replaces a removed part will assume the warranty service status of the removed part.

Before IBM or your reseller exchanges a Machine or part, you agree to remove all features, parts, options, alterations, and attachments not under warranty service.

You also agree to

1. ensure that the Machine is free of any legal obligations or restrictions that prevent its exchange;
2. obtain authorization from the owner to have IBM or your reseller service a Machine that you do not own; and
3. where applicable, before service is provided
 - a. follow the problem determination, problem analysis, and service request procedures that IBM or your reseller provides,
 - b. secure all programs, data, and funds contained in a Machine,
 - c. provide IBM or your reseller with sufficient, free, and safe access to your facilities to permit them to fulfill their obligations, and
 - d. inform IBM or your reseller of changes in a Machine's location.

IBM is responsible for loss of, or damage to, your Machine while it is 1) in IBM's possession or 2) in transit in those cases where IBM is responsible for the transportation charges.

Neither IBM nor your reseller is responsible for any of your confidential, proprietary or personal information contained in a Machine which you return to IBM or your reseller for any reason. You should remove all such information from the Machine prior to its return.

Production Status

Each IBM Machine is manufactured from new parts, or new and used parts. In some cases, the Machine may not be new and may have been previously installed. Regardless of the Machine's production status, IBM's appropriate warranty terms apply.

Limitation of Liability

Circumstances may arise where, because of a default on IBM's part or other liability, you are entitled to recover damages from IBM. In each such instance, regardless of the basis on which you are entitled to claim damages from IBM (including fundamental breach, negligence, misrepresentation, or other contract or tort claim), IBM is liable for no more than

1. damages for bodily injury (including death) and damage to real property and tangible personal property; and
2. the amount of any other actual direct damages, up to the greater of U.S. \$100,000 (or equivalent in local currency) or the charges (if recurring, 12 months' charges apply) for the Machine that is the subject of the claim.

This limit also applies to IBM's suppliers and your reseller. It is the maximum for which IBM, its suppliers, and your reseller are collectively responsible.

UNDER NO CIRCUMSTANCES IS IBM LIABLE FOR ANY OF THE FOLLOWING: 1) THIRD-PARTY CLAIMS AGAINST YOU FOR DAMAGES (OTHER THAN THOSE UNDER THE FIRST ITEM LISTED ABOVE); 2) LOSS OF, OR DAMAGE TO, YOUR RECORDS OR DATA; OR 3) SPECIAL, INCIDENTAL, OR INDIRECT DAMAGES OR FOR ANY ECONOMIC CONSEQUENTIAL DAMAGES (INCLUDING LOST PROFITS OR SAVINGS), EVEN IF IBM, ITS SUPPLIERS OR YOUR RESELLER IS INFORMED OF THEIR POSSIBILITY.

SOME JURISDICTIONS DO NOT ALLOW THE EXCLUSION OR LIMITATION OF INCIDENTAL OR CONSEQUENTIAL DAMAGES, SO THE ABOVE LIMITATION OR EXCLUSION MAY NOT APPLY TO YOU.

IBM Statement of Warranty Worldwide except Canada, Puerto Rico, Turkey, United States (Part 1 – General Terms)

This Statement of Warranty includes Part 1 - General Terms and Part 2 - Country-unique Terms. **The terms of Part 2 may replace or modify those of Part 1.** The warranties provided by IBM in this Statement of Warranty apply only to Machines you purchase for your use, and not for resale, from IBM or your reseller. The term "Machine" means an IBM machine, its features, conversions, upgrades, elements, or accessories, or any combination of them. The term "Machine" does not include any software programs, whether pre-loaded with the Machine, installed subsequently or otherwise. Unless IBM specifies otherwise, the following warranties apply only in the country where you acquire the Machine. Nothing in this Statement of Warranty affects any statutory rights of consumers that cannot be waived or limited by contract. If you have any questions, contact IBM or your reseller.

Machine - IBM @server xSeries 330

Warranty Period* - Three Years

*Contact your place of purchase for warranty service information. Some IBM Machines are eligible for On-site warranty service depending on the country where service is performed.

The IBM Warranty for Machines

IBM warrants that each Machine 1) is free from defects in materials and workmanship and 2) conforms to IBM's Official Published Specifications. The warranty period for a Machine is a specified, fixed period commencing on its Date of Installation. The date on your sales receipt is the Date of Installation, unless IBM or your reseller informs you otherwise.

During the warranty period IBM or your reseller, if approved by IBM to provide warranty service, will provide repair and exchange service for the Machine, without charge, under the type of service designated for the Machine and will manage and install engineering changes that apply to the Machine.

If a Machine does not function as warranted during the warranty period, and IBM or your reseller are unable to either 1) make it do so or 2) replace it with one that is at least functionally equivalent, you may return it to your place of purchase and your money will be refunded. The replacement may not be new, but will be in good working order.

Extent of Warranty

The warranty does not cover the repair or exchange of a Machine resulting from misuse, accident, modification, unsuitable physical or operating environment, improper maintenance by you, or failure caused by a product for which IBM is not responsible. The warranty is voided by removal or alteration of Machine or parts identification labels.

THESE WARRANTIES ARE YOUR EXCLUSIVE WARRANTIES AND REPLACE ALL OTHER WARRANTIES OR CONDITIONS, EXPRESS OR IMPLIED, INCLUDING, BUT NOT LIMITED TO, THE IMPLIED WARRANTIES OR CONDITIONS OF MERCHANTABILITY AND FITNESS FOR A PARTICULAR PURPOSE. THESE WARRANTIES GIVE YOU SPECIFIC LEGAL RIGHTS AND YOU MAY ALSO HAVE OTHER RIGHTS WHICH VARY FROM JURISDICTION

TO JURISDICTION. SOME JURISDICTIONS DO NOT ALLOW THE EXCLUSION OR LIMITATION OF EXPRESS OR IMPLIED WARRANTIES, SO THE ABOVE EXCLUSION OR LIMITATION MAY NOT APPLY TO YOU. IN THAT EVENT, SUCH WARRANTIES ARE LIMITED IN DURATION TO THE WARRANTY PERIOD. NO WARRANTIES APPLY AFTER THAT PERIOD.

Items Not Covered by Warranty

IBM does not warrant uninterrupted or error-free operation of a Machine.

Unless specified otherwise, IBM provides non-IBM machines **WITHOUT WARRANTIES OF ANY KIND.**

Any technical or other support provided for a Machine under warranty, such as assistance via telephone with "how-to" questions and those regarding Machine set-up and installation, will be provided **WITHOUT WARRANTIES OF ANY KIND.**

Warranty Service

To obtain warranty service for the Machine, contact your reseller or IBM. You may be required to present proof of purchase.

IBM or your reseller provides certain types of repair and exchange service, either at your location or at a service center, to keep Machines in, or restore them to, conformance with their Specifications. IBM or your reseller will inform you of the available types of service for a Machine based on its country of installation. IBM may repair the failing Machine or exchange it at its discretion.

When warranty service involves the exchange of a Machine or part, the item IBM or your reseller replaces becomes its property and the replacement becomes yours. You represent that all removed items are genuine and unaltered. The replacement may not be new, but will be in good working order and at least functionally equivalent to the item replaced. The replacement assumes the warranty service status of the replaced item.

Any feature, conversion, or upgrade IBM or your reseller services must be installed on a Machine which is 1) for certain Machines, the designated, serial-numbered Machine and 2) at an engineering-change level compatible with the feature, conversion, or upgrade. Many features, conversions, or upgrades involve the removal of parts and their return to IBM. A part that replaces a removed part will assume the warranty service status of the removed part.

Before IBM or your reseller exchanges a Machine or part, you agree to remove all features, parts, options, alterations, and attachments not under warranty service.

You also agree to

1. ensure that the Machine is free of any legal obligations or restrictions that prevent its exchange;
2. obtain authorization from the owner to have IBM or your reseller service a Machine that you do not own; and
3. where applicable, before service is provided
 - a. follow the problem determination, problem analysis, and service request procedures that IBM or your reseller provides,
 - b. secure all programs, data, and funds contained in a Machine,
 - c. provide IBM or your reseller with sufficient, free, and safe access to your facilities to permit them to fulfill their obligations, and
 - d. inform IBM or your reseller of changes in a Machine's location.

IBM is responsible for loss of, or damage to, your Machine while it is 1) in IBM's possession or 2) in transit in those cases where IBM is responsible for the transportation charges.

Neither IBM nor your reseller is responsible for any of your confidential, proprietary or personal information contained in a Machine which you return to IBM or your reseller for any reason. You should remove all such information from the Machine prior to its return.

Production Status

Each IBM Machine is manufactured from new parts, or new and used parts. In some cases, the Machine may not be new and may have been previously installed. Regardless of the Machine's production status, IBM's appropriate warranty terms apply.

Limitation of Liability

Circumstances may arise where, because of a default on IBM's part or other liability, you are entitled to recover damages from IBM. In each such instance, regardless of the basis on which you are entitled to claim damages from IBM (including fundamental breach, negligence, misrepresentation, or other contract or tort claim), IBM is liable for no more than

1. damages for bodily injury (including death) and damage to real property and tangible personal property; and
2. the amount of any other actual direct damages, up to the greater of U.S. \$100,000 (or equivalent in local currency) or the charges (if recurring, 12 months' charges apply) for the Machine that is the subject of the claim.

This limit also applies to IBM's suppliers and your reseller. It is the maximum for which IBM, its suppliers, and your reseller are collectively responsible.

UNDER NO CIRCUMSTANCES IS IBM LIABLE FOR ANY OF THE FOLLOWING: 1) THIRD-PARTY CLAIMS AGAINST YOU FOR DAMAGES (OTHER THAN THOSE UNDER THE FIRST ITEM LISTED ABOVE); 2) LOSS OF, OR DAMAGE TO, YOUR RECORDS OR DATA; OR 3) SPECIAL, INCIDENTAL, OR INDIRECT DAMAGES OR FOR ANY ECONOMIC CONSEQUENTIAL DAMAGES (INCLUDING LOST PROFITS OR SAVINGS), EVEN IF IBM, ITS SUPPLIERS OR YOUR RESELLER IS INFORMED OF THEIR POSSIBILITY. SOME JURISDICTIONS DO NOT ALLOW THE EXCLUSION OR LIMITATION OF INCIDENTAL OR CONSEQUENTIAL DAMAGES, SO THE ABOVE LIMITATION OR EXCLUSION MAY NOT APPLY TO YOU.

Part 2 - Worldwide Country-Unique Terms

ASIA PACIFIC

AUSTRALIA: The IBM Warranty for Machines: The following paragraph is added to this Section:

The warranties specified in this Section are in addition to any rights you may have under the Trade Practices Act 1974 or other legislation and are only limited to the extent permitted by the applicable legislation.

Extent of Warranty: The following replaces the first and second sentences of this Section:

The warranty does not cover the repair or exchange of a Machine resulting from misuse, accident, modification, unsuitable physical or operating environment,

operation in other than the Specified Operating Environment, improper maintenance by you, or failure caused by a product for which IBM is not responsible.

Limitation of Liability: The following is added to this Section:

Where IBM is in breach of a condition or warranty implied by the Trade Practices Act 1974, IBM's liability is limited to the repair or replacement of the goods or the supply of equivalent goods. Where that condition or warranty relates to right to sell, quiet possession or clear title, or the goods are of a kind ordinarily acquired for personal, domestic or household use or consumption, then none of the limitations in this paragraph apply.

PEOPLE'S REPUBLIC OF CHINA: Governing Law: The following is added to this Statement:

The laws of the State of New York govern this Statement.

INDIA: Limitation of Liability: The following replaces items 1 and 2 of this Section:

1. liability for bodily injury (including death) or damage to real property and tangible personal property will be limited to that caused by IBM's negligence;
2. as to any other actual damage arising in any situation involving nonperformance by IBM pursuant to, or in any way related to the subject of this Statement of Warranty, IBM's liability will be limited to the charge paid by you for the individual Machine that is the subject of the claim.

NEW ZEALAND: The IBM Warranty for Machines: The following paragraph is added to this Section:

The warranties specified in this Section are in addition to any rights you may have under the Consumer Guarantees Act 1993 or other legislation which cannot be excluded or limited. The Consumer Guarantees Act 1993 will not apply in respect of any goods which IBM provides, if you require the goods for the purposes of a business as defined in that Act.

Limitation of Liability: The following is added to this Section:

Where Machines are not acquired for the purposes of a business as defined in the Consumer Guarantees Act 1993, the limitations in this Section are subject to the limitations in that Act.

EUROPE, MIDDLE EAST, AFRICA (EMEA)

The following terms apply to all EMEA countries.

The terms of this Statement of Warranty apply to Machines purchased from an IBM reseller. If you purchased this Machine from IBM, the terms and conditions of the applicable IBM agreement prevail over this warranty statement.

Warranty Service

If you purchased an IBM Machine in Austria, Belgium, Denmark, Estonia, Finland, France, Germany, Greece, Iceland, Ireland, Italy, Latvia, Lithuania, Luxembourg, Netherlands, Norway, Portugal, Spain, Sweden, Switzerland or United Kingdom, you may obtain warranty service for that Machine in any of those countries from either (1) an IBM reseller approved to perform warranty service or (2) from IBM.

If you purchased an IBM Personal Computer Machine in Albania, Armenia, Belarus, Bosnia and Herzegovina, Bulgaria, Croatia, Czech Republic, Georgia, Hungary, Kazakhstan, Kirghizia, Federal Republic of Yugoslavia, Former Yugoslav Republic of Macedonia (FYROM), Moldova, Poland, Romania, Russia, Slovak Republic, Slovenia, or Ukraine, you may obtain warranty service for that Machine in any of those

countries from either (1) an IBM reseller approved to perform warranty service or (2) from IBM.

The applicable laws, Country-unique terms and competent court for this Statement are those of the country in which the warranty service is being provided. However, the laws of Austria govern this Statement if the warranty service is provided in Albania, Armenia, Belarus, Bosnia and Herzegovina, Bulgaria, Croatia, Czech Republic, Federal Republic of Yugoslavia, Georgia, Hungary, Kazakhstan, Kirghizia, Former Yugoslav Republic of Macedonia (FYROM), Moldova, Poland, Romania, Russia, Slovak Republic, Slovenia, and Ukraine.

The following terms apply to the country specified:

EGYPT: Limitation of Liability: The following replaces item 2 in this Section:
2. as to any other actual direct damages, IBM's liability will be limited to the total amount you paid for the Machine that is the subject of the claim.

Applicability of suppliers and resellers (unchanged).

FRANCE: Limitation of Liability: The following replaces the second sentence of the first paragraph of this Section:

In such instances, regardless of the basis on which you are entitled to claim damages from IBM, IBM is liable for no more than: (items 1 and 2 unchanged).

GERMANY: The IBM Warranty for Machines: The following replaces the first sentence of the first paragraph of this Section:

The warranty for an IBM Machine covers the functionality of the Machine for its normal use and the Machine's conformity to its Specifications.

The following paragraphs are added to this Section:

The minimum warranty period for Machines is six months.

In case IBM or your reseller are unable to repair an IBM Machine, you can alternatively ask for a partial refund as far as justified by the reduced value of the unrepaired Machine or ask for a cancellation of the respective agreement for such Machine and get your money refunded.

Extent of Warranty: The second paragraph does not apply.

Warranty Service: The following is added to this Section:

During the warranty period, transportation for delivery of the failing Machine to IBM will be at IBM's expense.

Production Status: The following paragraph replaces this Section:

Each Machine is newly manufactured. It may incorporate in addition to new parts, re-used parts as well.

Limitation of Liability: The following is added to this Section:

The limitations and exclusions specified in the Statement of Warranty will not apply to damages caused by IBM with fraud or gross negligence and for express warranty.

In item 2, replace "U.S. \$100,000" with "1.000.000 DEM."

The following sentence is added to the end of the first paragraph of item 2:

IBM's liability under this item is limited to the violation of essential contractual terms in cases of ordinary negligence.

IRELAND: Extent of Warranty: The following is added to this Section:

Except as expressly provided in these terms and conditions, all statutory conditions, including all warranties implied, but without prejudice to the generality of the foregoing all warranties implied by the Sale of Goods Act 1893 or the Sale of Goods and Supply of Services Act 1980 are hereby excluded.

Limitation of Liability: The following replaces items one and two of the first paragraph of this Section:

1. death or personal injury or physical damage to your real property solely caused by IBM's negligence; and 2. the amount of any other actual direct damages, up to the greater of Irish Pounds 75,000 or 125 percent of the charges (if recurring, the 12 months' charges apply) for the Machine that is the subject of the claim or which otherwise gives rise to the claim.

Applicability of suppliers and resellers (unchanged).

The following paragraph is added at the end of this Section:

IBM's entire liability and your sole remedy, whether in contract or in tort, in respect of any default shall be limited to damages.

ITALY: Limitation of Liability: The following replaces the second sentence in the first paragraph:

In each such instance unless otherwise provided by mandatory law, IBM is liable for no more than: (item 1 unchanged) 2) as to any other actual damage arising in all situations involving non-performance by IBM pursuant to, or in any way related to the subject matter of this Statement of Warranty, IBM's liability, will be limited to the total amount you paid for the Machine that is the subject of the claim.

Applicability of suppliers and resellers (unchanged).

The following replaces the second paragraph of this Section:

Unless otherwise provided by mandatory law, IBM and your reseller are not liable for any of the following: (items 1 and 2 unchanged) 3) indirect damages, even if IBM or your reseller is informed of their possibility.

SOUTH AFRICA, NAMIBIA, BOTSWANA, LESOTHO AND SWAZILAND:

Limitation of Liability: The following is added to this Section:

IBM's entire liability to you for actual damages arising in all situations involving nonperformance by IBM in respect of the subject matter of this Statement of Warranty will be limited to the charge paid by you for the individual Machine that is the subject of your claim from IBM.

TURKIYE: Production Status: The following replaces this Section:

IBM fulfills customer orders for IBM Machines as newly manufactured in accordance with IBM's production standards.

UNITED KINGDOM: Limitation of Liability: The following replaces items 1 and 2 of the first paragraph of this Section:

1. death or personal injury or physical damage to your real property solely caused by IBM's negligence; 2. the amount of any other actual direct damages or loss, up to the greater of Pounds Sterling 150,000 or 125 percent of the charges (if recurring, the 12 months' charges apply) for the Machine that is the subject of the claim or which otherwise gives rise to the claim.

The following item is added to this paragraph:

3. breach of IBM's obligations implied by Section 12 of the Sale of Goods Act 1979 or Section 2 of the Supply of Goods and Services Act 1982.

Applicability of suppliers and resellers (unchanged).

The following is added to the end of this Section:

IBM's entire liability and your sole remedy, whether in contract or in tort, in respect of any default will be limited to damages.

NORTH AMERICA

CANADA: Warranty Service: The following is added to this section:

To obtain warranty service from IBM, call **1-800-565-3344**.

UNITED STATES OF AMERICA: Warranty Service: The following is added to this section:

To obtain warranty service from IBM, call **1-800-772-2227**.

Notices

References in this publication to IBM products, programs, or services do not imply that IBM intends to make these available in all countries in which IBM operates. Any reference to an IBM product, program, or service is not intended to state or imply that only that IBM product, program, or service may be used. Subject to IBM's valid intellectual property or other legally protectable rights, any functionally equivalent product, program, or service may be used instead of the IBM product, program, or service. The evaluation and verification of operation in conjunction with other products, except those expressly designated by IBM, are the responsibility of the user.

IBM may have patents or pending patent applications covering subject matter in this document. The furnishing of this document does not give you any license to these patents. You can send license inquiries, in writing, to:

IBM Director of Licensing
IBM Corporation
North Castle Drive
Armonk, NY 10504-1785
U.S.A.

This section contains trademarks, electronic emission notices, and other important information.

Any references in this publication to non-IBM Web sites are provided for convenience only and do not in any manner serve as an endorsement of those Web sites. The materials at those Web sites are not part of the materials for this IBM product and use of those Web sites is at your own risk.

Edition Notice

INTERNATIONAL BUSINESS MACHINES CORPORATION PROVIDES THIS PUBLICATION "AS IS" WITHOUT WARRANTY OF ANY KIND, EITHER EXPRESS OR IMPLIED, INCLUDING, BUT NOT LIMITED TO, THE IMPLIED WARRANTIES OF MERCHANTABILITY OR FITNESS FOR A PARTICULAR PURPOSE. Some jurisdictions do not allow disclaimer of express or implied warranties in certain transactions, therefore, this statement may not apply to you.

This publication could include technical inaccuracies or typographical errors. Changes are periodically made to the information herein; these changes will be incorporated in new editions of the publication. IBM may make improvements and/or changes in the product(s) and/or the program(s) described in this publication at any time.

This publication was developed for products and services offered in the United States of America and the United Kingdom. It is possible that this publication may contain reference to, or information about, IBM products (machines and programs), programming, or services that are not announced in your country. Such references or information must not be construed to mean that IBM intends to announce such IBM products, programming, or services in your country.

Requests for technical information about IBM products should be made to your IBM reseller or IBM marketing representative. No part of this publication may be reproduced or distributed in any form or by any means without prior permission in writing from the International Business Machines Corporation.

© COPYRIGHT INTERNATIONAL BUSINESS MACHINES CORPORATION, 2000. All rights reserved.

Note to U.S. Government Users - Documentation related to restricted rights - Use, duplication or disclosure is subject to restrictions set forth in GSA ADP Schedule Contract with IBM Corp.

Processing date data

This IBM hardware product and IBM software products that might be packaged with it have been designed, when used in accordance with their associated documentation, to process date data correctly within and between the 20th and 21st centuries, provided all other products (for example, software, hardware, and firmware) used with these products properly exchange accurate date data with them.

IBM cannot take responsibility for the date data processing capabilities of non-IBM products, even if those products are preinstalled or otherwise distributed by IBM. You should contact the vendors responsible for those products directly to determine the capabilities of their products and update them if needed. This IBM hardware product cannot prevent errors that might occur if software, upgrades, or peripheral devices you use or exchange data with do not process date data correctly.

The foregoing is a Year 2000 Readiness Disclosure.

Trademarks

The following terms are trademarks of the IBM Corporation in the United States or other countries or both:

Alert on LAN	OS/2 Warp
Aptiva	PC Server
Chipkill	PC 300
DB2	Predictive Failure Analysis
@	ServeRAID
EtherJet	ServerGuide
HelpCenter	ServerProven
HelpWare	SurePath
IBM	TechConnect
IntelliStation	ThinkPad
Light Path Diagnostic	Update Connector
Netfinity	Wake on LAN
OS/2	

Lotus and Domino are trademarks of Lotus Development Corporation in the United States, other countries, or both.

Tivoli and NetView are trademarks of Tivoli Systems Inc. in the United States, other countries, or both.

Intel, MMX, LANDesk, Pentium, Pentium II Xeon, and Pentium III Xeon are trademarks or registered trademarks of Intel Corporation in the United States, other countries, or both.

Microsoft, Windows, Windows 2000, and Windows NT are trademarks or registered trademarks of Microsoft Corporation.

UNIX is a registered trademark of The Open Group in the United States and other countries.

Java and all Java-based trademarks and logos are trademarks or registered trademarks of Sun Microsystems, Inc. in the United States, other countries, or both.

Other company, product, and service names may be trademarks or service marks of others.

Important notes

Processor speeds indicate the internal clock speed of the microprocessor; other factors also affect application performance.

When referring to hard disk drive capacity, MB stands for 1000000 bytes and GB stands for 1000000000 bytes. Total user-accessible capacity may vary depending on operating environments.

Maximum internal hard disk drive capacities assume the replacement of any standard hard disk drives and population of all hard disk drive bays with the largest currently supported drives available from IBM.

Unless otherwise stated, IBM makes no representations or warranties with respect to non-IBM products. Support (if any) for the non-IBM products is provided by the third party, not IBM.

Some software may differ from its retail version (if available), and may not include user manuals or all program functionality.

Electronic emission notices

Federal Communications Commission (FCC) Statement

Federal Communications Commission (FCC) Class A Statement

Note: This equipment has been tested and found to comply with the limits for a Class A digital device, pursuant to Part 15 of the FCC Rules. These limits are designed to provide reasonable protection against harmful interference when the equipment is operated in a commercial environment. This equipment generates, uses, and can radiate radio frequency energy and, if not installed and used in accordance with the instruction manual, may cause harmful interference to radio communications. Operation of this equipment in a residential area is likely to cause harmful interference, in which case the user will be required to correct the interference at his own expense.

Properly shielded and grounded cables and connectors must be used in order to meet FCC emission limits. IBM is not responsible for any radio or television interference caused by using other than recommended cables and connectors or by unauthorized changes or modifications to this equipment. Unauthorized changes or modifications could void the user's authority to operate the equipment.

This device complies with Part 15 of the FCC Rules. Operation is subject to the following two conditions: (1) this device may not cause harmful interference, and (2) this device must accept any interference received, including interference that may cause undesired operation.

Industry Canada Class A emission compliance statement

This Class A digital apparatus complies with Canadian ICES-003.

Avis de conformité à la réglementation d'Industrie Canada

Cet appareil numérique de classe A est conforme à la norme NMB-003 du Canada.

Australia and New Zealand Class A statement

Attention: This is a Class A product. In a domestic environment this product may cause radio interference in which case the user may be required to take adequate measures.

United Kingdom telecommunications safety requirement

Notice to Customers

This apparatus is approved under approval number NS/G/1234/J/100003 for indirect connection to public telecommunication systems in the United Kingdom.

European Union EMC Directive conformance statement

This product is in conformity with the protection requirements of EU Council Directive 89/336/EEC on the approximation of the laws of the Member States relating to electromagnetic compatibility. IBM cannot accept responsibility for any failure to satisfy the protection requirements resulting from a nonrecommended modification of the product, including the fitting of non-IBM option cards.

This product has been tested and found to comply with the limits for Class A Information Technology Equipment according to CISPR 22/European Standard EN 55022. The Limits for Class A equipment were derived for commercial and industrial environments to provide reasonable protection against interference with licensed communication equipment.

Attention: This is a Class A product. In a domestic environment this product may cause radio interference in which case the user may be required to take adequate measures.

Taiwan electrical emission statement

警告使用者：
這是甲類的資訊產品，在
居住的環境中使用時，可
能會造成射頻干擾，在這
種情況下，使用者會被要
求採取某些適當的對策。

Japanese Voluntary Control Council for Interference (VCCI) statement

この装置は、情報処理装置等電波障害自主規制協議会（VCCI）の基準に
基づくクラスA情報技術装置です。この装置を家庭環境で使用すると電波妨害を
引き起こすことがあります。この場合には使用者が適切な対策を講ずるよう要求
されることがあります。

Power cords

For your safety, IBM provides a power cord with a grounded attachment plug to use with this IBM product. To avoid electrical shock, always use the power cord and plug with a properly grounded outlet.

IBM power cords used in the United States and Canada are listed by Underwriter's Laboratories (UL) and certified by the Canadian Standards Association (CSA).

For units intended to be operated at 115 volts: Use a UL-listed and CSA-certified cord set consisting of a minimum 18 AWG, Type SVT or SJT, three-conductor cord, a maximum of 15 feet in length and a parallel blade, grounding-type attachment plug rated 15 amperes, 125 volts.

For units intended to be operated at 230 volts (U.S. use): Use a UL-listed and CSA-certified cord set consisting of a minimum 18 AWG, Type SVT or SJT, three-conductor cord, a maximum of 15 feet in length and a tandem blade, grounding-type attachment plug rated 15 amperes, 250 volts.

For units intended to be operated at 230 volts (outside the U.S.): Use a cord set with a grounding-type attachment plug. The cord set should have the appropriate safety approvals for the country in which the equipment will be installed.

IBM power cords for a specific country or region are usually available only in that country or region.

IBM power cord part number	Used in these countries and regions
13F9940	Argentina, Australia, China (PRC), New Zealand, Papua New Guinea, Paraguay, Uruguay, Western Samoa
13F9979	Afghanistan, Algeria, Andorra, Angola, Austria, Belgium, Benin, Bulgaria, Burkina Faso, Burundi, Cameroon, Central African Rep., Chad, Czech Republic, Egypt, Finland, France, French Guiana, Germany, Greece, Guinea, Hungary, Iceland, Indonesia, Iran, Ivory Coast, Jordan, Lebanon, Luxembourg, Macau, Malagasy, Mali, Martinique, Mauritania, Mauritius, Monaco, Morocco, Mozambique, Netherlands, New Caledonia, Niger, Norway, Poland, Portugal, Romania, Senegal, Slovakia, Spain, Sudan, Sweden, Syria, Togo, Tunisia, Turkey, former USSR, Vietnam, former Yugoslavia, Zaire, Zimbabwe
13F9997	Denmark
14F0015	Bangladesh, Burma, Pakistan, South Africa, Sri Lanka
14F0033	Antigua, Bahrain, Brunei, Channel Islands, Cyprus, Dubai, Fiji, Ghana, Hong Kong, India, Iraq, Ireland, Kenya, Kuwait, Malawi, Malaysia, Malta, Nepal, Nigeria, Polynesia, Qatar, Sierra Leone, Singapore, Tanzania, Uganda, United Kingdom, Yemen, Zambia
14F0051	Liechtenstein, Switzerland
14F0069	Chile, Ethiopia, Italy, Libya, Somalia
14F0087	Israel
1838574	Thailand
6952300	Bahamas, Barbados, Bermuda, Bolivia, Brazil, Canada, Cayman Islands, Colombia, Costa Rica, Dominican Republic, Ecuador, El Salvador, Guatemala, Guyana, Haiti, Honduras, Jamaica, Japan, Korea (South), Liberia, Mexico, Netherlands Antilles, Nicaragua, Panama, Peru, Philippines, Saudi Arabia, Suriname, Taiwan, Trinidad (West Indies), United States of America, Venezuela

Index

A

- acoustical noise emissions 2
- adapter
 - installing 45
 - PCI bus 45
 - RAID 49
 - ServeRAID 48
 - working with 44
- adapter fault tolerance 65
- adaptive load balancing 65
- administrator password 20
- Advanced System Management Cabling 69
- Advanced System Management ports 68
- assistance, technical 124

B

- battery replacement 122
- beep codes
 - POST 78
- BIOS, restoring 103
- boot block jumper 32

C

- C2T cable 71
- Cable Chain Technology 71
- cable management 73
- cabling
 - advanced system management 69
 - connectors on back 69
 - Ethernet 64
 - RS-485 69
- CD-ROM drive 2
- CD-ROM problems 109
- CDs
 - ServerGuide 26
- components
 - location of 31
 - major 31
- configuration
 - ServerGuide CDs 13
 - with ServerGuide 27
- Configuration/Setup Utility program 13, 14
- configuring
 - Ethernet 64
- connectors
 - system board 32
- connectors, external 58
- controller
 - Ethernet 64
 - RAID 47
- controls and indicators 6
- cover
 - installing 57
 - removing 43
- creating VLAN 67

D

- data rate
 - Ethernet 64

- diagnostic
 - error code format 91
 - error message tables 95
 - programs and error messages 91
 - programs, starting 93
 - test log, viewing 94
 - text messages 92
- diagnostic tools 75
- DIMM See memory module 50
- diskette drive 2
 - problem 109
- display
 - problem 111

E

- electrical input 2
- environment
 - air temperature 2
 - humidity 2
- error
 - diagnostic code format 91
- error log
 - POST 90
- error messages
 - diagnostic 91, 95
 - POST 82
 - SCSI 90
- Ethernet
 - adapter fault tolerance 65
 - adaptive load balancing 65
 - cabling 64
 - Cisco Fast EtherChannel 65
 - configuring 64
 - creating VLAN 67
 - error messages 117
 - failover 64
 - high-performance modes 65
 - IntraNetWare error messages 117
 - NetWare error messages 117
 - pin-number assignment 67
 - priority packet mode 65
 - priority filters 65
 - ServeRAID 48
 - teaming 65
 - teaming error messages 121
 - troubleshooting information 115
 - VLAN 66
 - Windows NT error messages 119
- Ethernet port 64
- expansion bays 2
- expansion enclosure
 - problem 109
- expansion slots 2
 - location 44
 - type 44

F

- failover
 - Ethernet 64
- fan, replacing 56
- FCC

- Class A Statement 144
- features 2
 - ServerGuide 26
- filters
 - priority 65

H

- hard disk drive
 - installing 49
 - replacing 49
 - specifications 48
- hardware
 - problems 75
- heat output 2
- help information 124
- high priority queue 65
- hot-swap
 - preinstallation steps 48

I

- I/O ports 58
- IEEE 802.1p tagging 65
- important notes 144
- installing
 - battery 122
 - C2T cables 69
 - cover 57
 - hard disk drive 49
 - memory 50
 - microprocessor 53
- installing options 31
- integrated
 - Ethernet 64

J

- jumper
 - power-on password override 19

K

- keyboard
 - problem 110

L

- LEDs
 - front view 6
 - rear view 7
- light path diagnostic panel 6, 7
- Light Path Diagnostics 105
- Light Path Diagnostics table 107
- Light Path Diagnostics panel 106
- Lights See LEDs 6
- local area network
 - Ethernet 64

M

- major components 31
- management
 - cable 73

- memory
 - installing 50
 - problem 111
 - specifications 2
- memory module
 - installing 50
 - specifications 2, 4
 - supported 50
- messages
 - diagnostic error 91, 95
 - diagnostic text 92
 - Ethernet controller 117
 - Ethernet teaming error 121
 - POST error 82
 - SCSI error 90
- microprocessor
 - installation 53
 - installing 52
 - problem 111
 - specifications 2
- modes
 - Ethernet 65
- monitor
 - problem 111
- mouse
 - problem 110

N

- network connection
 - problems 115
- networks 64
- NOS installation
 - with ServerGuide 28
 - without ServerGuide 29

O

- option
 - problem 112

P

- password
 - administrator 20
 - override jumper 19
 - power-on 19
- PCI
 - bus A 45
 - bus B 45
 - expansion slots 44
- PCI plug and play
 - Ethernet 64
- pin-number assignments
 - Ethernet 67
- plug and play
 - Ethernet 64
- pointing device
 - problem 110
- port
 - console 61
 - I/O 58
 - RS-485 58
 - serial 59
 - serial connector 60
 - USB 60
 - USB connector 61
- ports
 - Ethernet 64
 - Universal Serial Bus 60
- POST
 - beep codes 78
 - error log 90

- error messages 82
- POST (power-on self-test) 77
- POST error logs 75
- power
 - problem 113
- power cords 146
- power supply
 - specifications 2
- power-on password 19
- priority filters 65
- priority levels 65
- priority packet mode 65
- problem
 - CD-ROM 109
 - diskette drive 109
 - hardware 75
 - intermittent 110
 - keyboard or mouse 110
 - memory 111
 - microprocessor 111
 - monitor 111
 - network connection 115
 - option 112
 - power 113
 - serial port 113
 - software 113
 - USB port 114
- problem solving 75
- PXE boot agent utility 13

R

- RAID See adapter 48, 49
- replace
 - fan 56
 - hard disk 49
- RS-485 68

S

- Safety information 37
- safety information
 - book v, 37
- SCSI
 - error messages 90
- SCSISelect Utility program 13, 21
- serial port
 - problem 113
- ServeRAID Configuration program 13
- ServerGuide
 - additional programs 29
 - CDs 13
 - features 26
 - NOS installation 28
 - setting up multiple servers 29
 - using 25
- ServerGuide CDs 4
- service information 124
- setting up
 - multiple servers 29
- setup
 - with ServerGuide 27
- size 2
- Slots See expansion slots 32, 34
- slots See expansion slots 44
- software
 - problem 113
- software coupon
 - ServerGuide 25
- specifications 2
- switch block, system board 33
- system board layout
 - connectors

- options 32
- system board switch block 33
- system management 4, 68

T

- teaming 65
- teaming error messages 121
- test log
 - viewing diagnostic 94
- testing C2T chain 73
- trademarks 143
- traffic class expediting 65
- troubleshooting 75
 - Ethernet 115
- troubleshooting charts 109

U

- USB
 - cables and hubs 60
 - port connectors 61
- USB port
 - problem 114

V

- video controller
 - disabling 44
 - specifications 2
- virtual LAN (VLAN) 66
- virtual LAN mode (VLAN) 66
- VLAN, creating 67

W

- Web site
 - ServerGuide 25



Part Number: 06P4574

File Number:

06P4574

06P4574